



**Let's continue writing a more
sustainable future**

2 0 2 0



committed with — — the environment

FR> Engagé pour l'environnement
ES> Comprometidos con el medio ambiente
DE> Der Umwelt verpflichtet
IT> Impegnata nella salvaguardia dell'ambiente.



ECO WRITING INSTRUMENTS

- 11** BIC® Media Clic Bio Ecolutions
- 14** BIC® Media Clic Ecolutions
- 18** BIC® Round Stic Ecolutions
- 20** BIC® Clic Stic Ecolutions
- 22** BIC® Super Clip Ecolutions
- 24** BIC® Wide Body Ecolutions
- 26** BIC® Matic Ecolutions
- 28** BIC® Evolution Ecolutions
- 32** Sprout
- 34** BIC® Permanent Marker Ecolutions

BIC® STICKY NOTES ECOLUTIONS

- 36** BIC® 50 mm x 75 mm ADHESIVE NOTEPADS Ecolutions
- 37** BIC® 68 mm x 75 mm ADHESIVE NOTEPADS Ecolutions
- 38** BIC® 75 mm x 75 mm ADHESIVE NOTEPADS Ecolutions
- 39** BIC® 101 mm x 75 mm ADHESIVE NOTEPADS Ecolutions
- 40** BIC® MEDIUM ADHESIVE DIE CUT NOTEPADS Ecolutions
- 42** BIC® 101 mm x 101 mm ADHESIVE NOTEPADS Ecolutions
- 44** BIC® 101 mm x 130 mm ADHESIVE NOTEPADS Ecolutions

BIC® PACKAGING ECOLUTIONS

- 48** BIC® Packaging Ecolutions



FR> Produits durables

L'engagement du Groupe "Writing The Future, Together", formulé en 2017, signe une nouvelle étape dans la démarche engagée par BIC depuis 2004. Ces **engagements ambitieux à horizon 2025**, essentiels à la stratégie de l'entreprise, engagent BIC vers une philosophie **d'action et de transformation** qui influence l'intégralité de l'entreprise.

Cet engagement couvre cinq domaines stratégiques

01 Favoriser l'innovation durable dans les produits BIC. Un design simple et inventif, nécessitant peu de matières premières et garantissant une longue durée de vie.

02 Agir contre le changement climatique. Le Groupe BIC adopte une approche globale au regard de la consommation énergétique (efficacité énergétique, utilisation d'énergies renouvelables, etc.),

03 S'engager pour la sécurité au travail. Le Groupe objectif : offrir un environnement de travail sûr et propice au développement.

04 Impliquer les fournisseurs de manière proactive. Notre équipe Achats analyse l'ensemble des risques, puis sélectionne nos fournisseurs stratégiques et travaille de concert avec ces derniers en adoptant une démarche responsable.

05 S'investir pour une vie meilleure à travers l'éducation. L'éducation, qui a le pouvoir de changer le monde, a toujours été au centre des préoccupations du Groupe.

ES> Productos sostenibles

El compromiso del Grupo "Escribiendo el futuro, juntos", elaborado en 2017, es el siguiente paso en un viaje que BIC comenzó en 2004. Este programa **ambicioso para 2025**, integrado en la estrategia de la Compañía, compromete a BIC en una filosofía de acción y transformación que tiene impacto en toda la compañía.

Se aplica en 5 áreas estratégicas

01. Fomentando la innovación de los productos BIC. Diseños simples e inventivos, con menos materia prima y más rendimiento.

02. Actuando contra el cambio climático. Un acercamiento global al consumo de energía (energía eficiente, uso de energía renovable, etc.)

03. Compromiso para salvar el medio ambiente. BIC tiene el objetivo de proveer un espacio de trabajo seguro y propicio.

04. Involucrando proactivamente a proveedores. Nuestros equipos de compra analizan todos los riesgos, seleccionan y colaboran con nuestros proveedores más estratégicos que siguen una adquisición responsable.

05. Mejorando vidas a través de la educación. La educación tiene el poder de cambiar el mundo, y por ello siempre ha estado en el corazón de las inquietudes del grupo.

DE> Nachhaltige Produkte

Das Engagement der Gruppe „Die Zukunft gemeinsam schreiben“, formuliert im Jahr 2017, ist der nächste Schritt auf der Reise, die BIC im Jahr 2004 startete. Dieses **ambitiöse 2025 Programm**, wesentlich in der Firmenstrategie, strebt nach einer Philosophie der **Leistung und Transformation**, die die gesamte Firma prägt.

Sie wird in fünf verschiedenen strategischen Gebieten angewandt:

01 Förderung nachhaltiger Innovation bei BIC Produkten. Einfache, einfallreiche Designs, mit weniger Rohmaterial und langlebiger Leistung

02 Klimawandel entgegensteuern. Eine globale Herangehensweise an den Energieverbrauch (Energieeffizienz, Gebrauch von erneuerbaren Energien, etc.)

03 Selbstverpflichtung zu einem sicheren Umfeld. BIC strebt danach ein sicheres und förderndes Arbeitsumfeld zu bieten.

04. Proaktiv Lieferanten miteinbeziehen. Unsere Kaufteams analysieren alle Risiken, wählen und kollaborieren mit unseren strategischsten Lieferanten gemäß einer Verantwortungsbewussten Herangehensweise.

05 Leben verbessern durch Bildung. Weil Bildung die Möglichkeit schafft die Welt zu verändern, lag diese der Gruppe immer am Herzen.

IT> Prodotti sostenibili

L'impegno preso dal Gruppo nel 2017, "Writing the Future, Together", è il prossimo passo in un percorso iniziato da BIC nel 2004. Questo **ambizioso programma 2025**, parte integrante della strategia della Società, impegna BIC al perseguimento di una filosofia di **azione e trasformazione** il cui impatto influisce sull'intera società.

Applicazione in cinque aree strategiche

01 Incentivo all'innovazione sostenibile nei prodotti BIC. Design semplici e innovativi con meno materie prime e prestazioni che durano nel tempo.

02 Azione contro i cambiamenti climatici. Un approccio globale al consumo energetico (efficienza energetica, uso di energia proveniente da fonti rinnovabili, ecc.).

03 Impegno verso un ambiente sicuro. BIC mira a fornire un ambiente di lavoro sicuro e che favorisca la crescita professionale.

04 Coinvolgimento proattivo dei fornitori. Il nostro team acquisti analizza tutti i rischi, seleziona e collabora con i fornitori più strategici seguendo un approccio responsabile.

05 Miglioramento delle vite grazie all'istruzione. Poiché l'istruzione ha il potere di cambiare il mondo, è sempre stato il cuore delle istanze del Gruppo.





Writing the sustainable future together

The Group's "Writing the Future, Together" commitment, formulated in 2017, is the next step in a journey BIC started in 2004. This **ambitious by 2025 program**, integral to the Company's strategy, commits BIC to a philosophy of **action and transformation** that impacts the whole company.

It is applied in five strategic areas

01 **FOSTERING SUSTAINABLE INNOVATION IN BIC PRODUCTS**

Simple, inventive designs, with less raw materials and long life performance.

02 **ACTING AGAINST CLIMATE CHANGE**

A global approach to energy consumption (energy efficiency, use of renewable energy, etc.).

03 **COMMITTING TO A SAFE ENVIRONMENT**

BIC aims to provide a safe and nurturing workplace.

04 **PROACTIVELY INVOLVING SUPPLIERS**

Our purchasing teams analyse all the risks, select and collaborate with our most strategic suppliers following a responsible approach.

05 **IMPROVING LIVES THROUGH EDUCATION**

Because education has the power to change the world, it has always been at the heart of the Group's concerns.



Watch the video and learn more about Sustainable development
bicworld.com/en/our-commitments/overview

FR> Agir contre le changement climatique

L'utilisation d'une énergie renouvelable contribuera à réduire de manière notable les émissions de gaz à effet de serre générées par BIC d'ici à 2025.

L'engagement du groupe bic pour 2025
D'ici 2025, BIC utilisera de l'électricité à 80 % d'origine renouvelable.

Où se place BIC Graphic europe en 2020 ?
Le usine et nos installations d'impression BIC Graphic de Tarragone sont alimentées avec de l'électricité 100% renouvelable.

ES> Actuando contra el cambio climático

El uso de electricidad renovable contribuirá a reducir las emisiones de gas invernadero de BIC significativamente para 2025.

Compromiso del grupo bic para 2025
Para 2025 BIC usará un 80% de electricidad renovable.

¿Dónde estará BIC Graphic en 2020?
La fábrica y las técnicas de impresión están usando el 100% de electricidad renovable.

DE> Dem Klimawandel entgegensteuern

Der Gebrauch von erneuerbarem Strom wird zur Reduktion von BIC's Treibhausgasemissionen bis 2025 beitragen.

BIC gruppe selbstverpflichtung 2025
Im Jahr 2025 wird BIC 80 % erneuerbaren Strom nutzen.

Wo ist BIC Graphic Europe im Jahr 2020
Fabriken und Druckeinrichtungen benutzen 100 % erneuerbaren Strom.

IT> Azione contro il climate change

L'uso di energia elettrica proveniente da fonti rinnovabili contribuirà a ridurre le emissioni di gas serra di BIC entro il 2025.

L'impegno di bic per il 2025
Entro il 2025 BIC utilizzerà l'80% di energia elettrica da fonti rinnovabili.

A che punto è BIC Graphic nel 2020?
Gli stabilimenti e gli impianti di stampa utilizzando il 100% di energia elettrica da fonti rinnovabili.

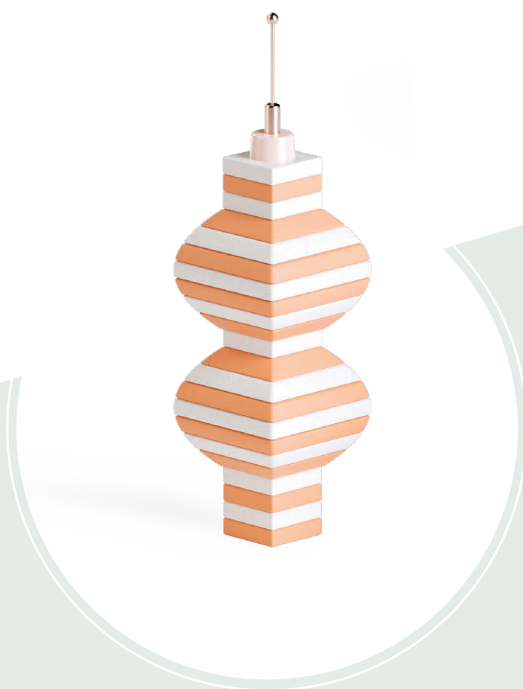



Acting against — — **climate change**

The use of renewable electricity will contribute to reducing BIC's greenhouse gas emissions significantly by 2025.

BIC GROUP COMMITMENT FOR

2025

By 2025, BIC will use 80% renewable electricity.



WHERE IS BIC GRAPHIC EUROPE IN 2020?

Factory and printing facilities are using

100%

renewable electricity.

FR> Produits durables

Ubicuity™ : un modèle d'économie circulaire unique

Dès 2011, le Groupe s'est associé en Europe à **TerraCycle**, entreprise pionnière du recyclage des déchets en plastique petits et complexes, pour créer de toutes pièces un programme de collecte des instruments d'écriture, quel que soit leur fabricant, sur les lieux mêmes de consommation (écoles, bureaux, etc.). En 2017, BIC a lancé **Ubicuity™**, une gamme de mobilier extérieur, fabriquée à partir de cette matière collectée, et commercialisée par la société française Plas Eco auprès des collectivités et de nombreux établissements scolaires.

100 % des BIC instruments d'écriture sont recyclables grâce à Ubicuity™ renouvelable.

Vous collectez / Nous recyclons / Nous transformons

ES> Productos sostenibles

Ubicuity™: un modelo económico circular único

En 2011, BIC se asoció en Europa con **TerraCycle**, una firma pionera en la industria del reciclaje de plásticos. Juntos crearon un vasto programa para recoger todos los instrumentos de escritura, independientemente de su fabricación, directamente de donde son usados, en escuelas, oficinas, etc. En 2017, BIC presentó **Ubicuity™**, una gama única de mobiliario exterior hecho exclusivamente de estos plásticos reciclados recolectados por la empresa francesa Plas Eco.

100% de los instrumentos de escritura de BIC son reciclados gracias a Ubicuity™

Tu recoges / Nosotros reciclamos / Nosotros transformamos

DE> Nachhaltige Produkte

Ubicuity™: ein einzigartiges Kreislaufwirtschaftsmodell

Bereits im Jahr 2011 schloss sich BIC in Europa mit **TerraCycle** zusammen, einer Pionierfirma in der Plastik Recycling Industrie. Zusammen gründeten sie ein weitreichendes Programm um alle Schreibinstrumente, unbeachtet von welchem Hersteller, zu sammeln. Direkt dort, wo sie benutzt werden, in Schulen, Büros, etc. In 2017 führte BIC **Ubicuity™** ein, eine einzigartige Produktreihe von Gartenmöbeln, ausschließlich hergestellt aus recyceltem Plastik, gesammelt von der französischen Firma Plas Eco. 100% der Schreibinstrumente sind Dank Ubicuity™ recycelbar.

100% der Schreibinstrumente sind Dank Ubicuity™ recycelbar.

Sie sammeln / Wir recyceln / Wir verwandeln

IT> Prodotti sostenibili

Ubicuity™: un modello unico di economia circolare

Nel 2011 BIC ha unito le forze con **TerraCycle**, un'azienda pionieristica nel settore del riciclo della plastica. Insieme hanno creato un ampio programma per raccogliere tutti gli strumenti di scrittura, indipendentemente dal produttore, direttamente dal luogo in cui questi vengono utilizzati (scuole, uffici, ecc.). Nel 2017, BIC ha introdotto **Ubicuity™**, una gamma unica di complementi d'arredo per il giardino realizzati esclusivamente dalla plastica riciclata raccolta dall'azienda francese Plas Eco.

Il 100% degli strumenti di scrittura BIC sono riciclabili grazie a Ubicuity™

Tu raccogli / Noi ricicliamo / Noi ricicliamo





Watch the video
The "write" kind of bench

Ubicuity™ : a unique circular economy model

In 2011, BIC partnered in Europe with **TerraCycle**®, a pioneering firm in the plastics recycling industry. Together, they created a vast program to collect all writing instruments, regardless of manufacturer, directly from where they are used, in schools, offices, etc. In 2017, BIC introduced **Ubicuity™**, a one-of-a-kind range of outdoor furniture made exclusively from these collected recycled plastics by French company Plas Eco.

100% of BIC® writing instruments are recyclable thanks to Ubicuity™

1

2

3

YOU COLLECT



WE RECYCLE



WE TRANSFORM



FR> La responsabilité sociale d'entreprise BIC' Graphic**ISO 9001 - ISO 14001**

Par Lloyd's Register, relatifs aux systèmes de gestion intégrée pour les installations de Tarragone (Espagne).

Nos produits certifiés NF :

Certification NF attestant la conformité des produits et des services suivant les normes nationales et internationales européennes.

Coca-Cola / Un score de 0 non-conformité

L'audit de Coca-cola a été passé avec brio en obtenant le meilleur résultat positif pour une audit dans le domaine du respect des normes de travail, des droits humains, de la santé et la sécurité, de la gestion environnementale et de l'intégrité commerciale.

AMFORI:

Membre de l'association d'entreprises leader dans le monde pour le commerce ouvert et durable. Elle rassemble plus de 2 400 détaillants, importateurs, marques et associations répartis dans plus de 40 pays.

SMETA 4-pillar audited

4 Piliers : Environnement

Éthique des affaires

Santé et Sécurité Normes du travail

UN Global Compact

Membre officiel de la famille du Pacte mondial des Nations Unies, -la plus importante initiative de durabilité des entreprises au monde.

ECOVADIS

Reconnaissance gold

BIC Graphic s'est vu décerner un niveau de reconnaissance GOLD par Ecovadis

Des sites web au bilan carbone neutre:

Collaboration à l'initiative de durabilité avec le Global Climate Institute.

IMPRIM' VERT

Qualifié et référencé pour IMPRIM' VERT. Engagement des entreprises dans le domaine de l'impression pour la réduction de l'impact de leur activité sur l'environnement.

Workplace Conditions Assessment

Classé comme conforme aux exigences du programme Workplace Conditions Assessment

Our Awards

PSI Sustainability Awards / Pour la troisième année consécutive 2017-2019

2019 1e place Excellence

Économique. Nous basant sur un système de contrôle qualité strict 2017 1e place Excellence

Économique. 1e place Produits durables

2018 1e place Initiative sociale

3e place Initiative pour l'environnement

ES> La responsabilidad social de BIC' Graphic Corporación**ISO 9001 - ISO 14001**

Sistema integrado de gestión de certificaciones para las instalaciones de Tarragona de Lloyd's Register.

Nuestro certificado de productos NF

La Certificación NF da fe de la conformidad de productos y servicios con los documentos normativos nacionales, europeos e internacionales.

Coca-Cola / Resultado de 0 no conformidades

La auditoría social de Coca-Cola pasó con la máxima puntuación en términos de cumplimiento con las Normas Laborales y Derechos Humanos, Salud y Seguridad, Gestión Medioambiental y Negocios de Integridad

AMORFI:

Miembros de la asociación global empresarial líder para el comercio abierto y sostenible. Juntan más de 2400 minoristas, importadores, marcas y asociaciones de más de 40 países.

SMETA 4 pilares auditados

4 pilares: medioambiental, ética de negocio, salud y seguridad, trabajo

UN Global Compact

Somos parte oficial de la familia del Compacto Global de las Naciones Unidas, la iniciativa corporativa sostenible más grande del mundo.

ECOVADIS

Reconocimiento dorado

Nos ha sido otorgada la medalla de oro por Ecovadis.

Carbon neutral website

Miembros de la nueva iniciativa sostenible en colaboración con el Instituto del Clima Global.

IMPRIM' VERT

Calificados por IMPRIM' VERT, un compromiso para actividades de impresión empresarial para reducir el impacto de su actividad en el medio ambiente.

Workplace Conditions Assessment

Evaludos por Intertek con la conformidad a los requerimientos de: Evaluación de las Condiciones del Puesto de Trabajo.

Our Awards

PSI Sustainability Awards / Tres años consecutivos 2017-2019 2019 1r puesto Excelencia

Económica basada en una estricta estructura de cualidad de gestión del sistema.

2017 1r puesto

Excelencia económica

1r puesto Productos sostenibles

2018

1r puesto Iniciativa social

3r puesto Iniciativa medioambiental

DE> BIC' Graphic Corporate social responsibility**ISO 9001 - ISO 14001**

Zertifizierungen für integrierte Qualitäts- und Umweltmanagementsysteme für ihre Werke in Tarragona (Spanien) vom Lloyd's Register erhalten.

Unsere NF-zertifizierten Produkte:

NF Zertifikate garantieren die Übereinstimmung der Produkte und Leistungen mit nationalen, europäischen und internationalen, normativen Dokumenten.

Coca-Cola / Ergebnis von 0 Nichtkonformitäten

Das Coca-Cola Sozialaudit wurde bestanden mit dem höchsten positiven Auditergebnis in Bezug auf Übereinstimmung mit Arbeitsstandards und Menschenrechten, Gesundheit und Sicherheit, Umwelt Management und wirtschaftlicher Integrität.

AMFORI:

Mitglied der führenden, globalen Wirtschafts Vereinigung für einen offenen und nachhaltigen Handel. Sie bringen mehr als 2400 Einzelhändler, Importeure, Marken und Vereinigungen aus mehr als 40 Ländern zusammen.

SMETA 4 aktionsschwerpunkte geprüft

4 Aktionsschwerpunkte: Umwelt, Wirtschafts Ethik, Gesundheit und Sicherheit, Arbeit.

UN Global Compact

ist offiziell Teil der Familie des UN Global Compact - der weltweit größten Initiative für Nachhaltigkeit von Unternehmen.

ECOVADIS

gold anerkennung

Wurde mit dem Gold Anerkennungsgrad von Ecovadis Ausgezeichnet.

Klimaneutrale websites: Teil der neuen Nachhaltigkeitsinitiative in Zusammenarbeit mit dem Global Climate Institute.

IMPRIM' VERT

Qualifiziert durch IMPRIM' VERT.

Ein Engagement für wirtschaftliche Drucktätigkeiten, die Auswirkungen ihrer Aktivitäten auf die Umwelt zu reduzieren.

Workplace Conditions Assessment

Wurde von Intertek als übereinstimmend mit den Konditionen von Workplace Condition Assessment eingeschätzt.

Our Awards

PSI Sustainability Awards / Zum dritten Mal in Folge 2017-2019

2019 - 1. Platz Economic Excellence

Basierend auf einem

strikt strukturiertem

Qualitätsmanagement System

2017 - 1. Platz Economic Excellence

1. Platz Sustainable products

2018 - 1. Platz Social initiative

3. Platz Environment initiative

IT> Corporate social responsibility di BIC' Graphic**ISO 9001 - ISO 14001**

Certificazioni per il sistema di gestione integrata delle strutture di Tarragona da parte del Lloyd's Register.

I nostri prodotti certificati NF

La certificazione NF attesta la conformità dei prodotti e dei servizi alle normative nazionali, europee e internazionali.

Coca-Cola / Punteggio di 0 non conformità

Il social audit di Coca-Cola è stato superato con il massimo risultato in termini di conformità con gli standard lavorativi, di rispetto dei diritti umani, salute e sicurezza sul luogo di lavoro, gestione ambientale e integrità aziendale.

AMFORI

Membro dell'associazione leader mondiale per il commercio aperto e sostenibile. Raggruppa oltre 2.400 commercianti, importatori, brand e associazioni di oltre 40 Paesi.

Audit 4 pilastri SMETA

4 pilastri: ambiente, etica aziendale, salute e sicurezza, lavoro

UN Global Compact

Ufficialmente parte della famiglia UN Global Compact - la più grande iniziativa a livello mondiale per la sostenibilità aziendale.

ECOVADIS

Livello Gold recognition da parte di Ecovadis.

Siti web carbon neutral

Membri della nuova iniziativa per la sostenibilità in collaborazione con il Global Climate Institute.

IMPRIM' VERT

Qualificato da IMPRIM' VERT. Un impegno da parte delle aziende che operano nel settore della stampa a ridurre l'impatto ambientale delle loro attività.

Workplace conditions assesment

Certificato da Intertek conforme ai requisiti del Workplace Conditions Assessment

I nostri riconoscimenti

PSI Sustainability Awards /

Per tre anni consecutivi 2017-2019

2019 1° POSTO Economic

Excellence. Basato su un sistema di gestione della qualità strutturato in modo rigido

2017 1° POSTO Eccellenza

economica. 1° POSTO Prodotti

sostenibili

2018 1° POSTO Iniziativa sociale.

3° POSTO Iniziativa ambientale

BIC® Graphic Corporate social responsibility



ISO 9001 - ISO 14001

Integrated Management System Certifications for the Tarragona facilities from Lloyd's Register.



OUR NF CERTIFIED PRODUCTS:

NF Certification attests to the conformity of products and services with national, European and international normative documents



SCORE OF 0 NON - CONFORMITIES

Coca-Cola social audit passed with the maximum positive audit result in terms of compliance with Labour Standards & Human Rights, Health & Safety, Environmental Management and Business Integrity.



AMFORI:

Member of the leading global business association for open and sustainable trade. They bring together over 2,400 retailers, importers, brands and associations from more than 40 countries.



SMETA 4-PILLAR AUDITED

4 Pillars:
Environmental, Business Ethics, Health & Safety, Labour



United Nations Global Compact

UN GLOBAL COMPACT

Is officially part of the UN Global Compact family - **the world's largest corporate sustainability initiative.**



GOLD RECOGNITION

Has been granted a Gold recognition level by Ecovadis.



CARBON NEUTRAL WEBSITES:

Members of the a new sustainability initiative in collaboration with Global Climate Institute.



IMPRIM' VERT

Qualified by IMPRIM'VERT. A commitment for printing activities business, to reduce the impact of their activity on the environment



WORKPLACE CONDITIONS ASSESSMENT

WORKPLACE

Has been assessed by Intertek as conforming to the requirements of: **Workplace Conditions Assessment**



Our Awards



FOR THREE YEARS IN A ROW 2017-2019

2019

1st PLACE
Economic Excellence
Based on a strictly structured quality management system

2017

1st PLACE
Economic Excellence
1st PLACE
Sustainable products

2018

1st PLACE
Social initiative
3rd PLACE
Environment initiative



BIC Graphic helps you to promote your brand with sustainable materials



ecolutions®

The Ecolutions® range is created based on 4 sustainable materials

FR> La gamme Ecolutions® repose sur 3 matériaux durables

ES> La gama Ecolutions® está creada en base a 3 materiales sostenibles

DE> Die Ecolutions® Produktlinie wurde auf der Grundlage von drei nachhaltigen Materialien konzipiert

IT> La gamma Ecolutions si crea in base a 3 materiali sostenibili.

1



The plastic of our products is reprocessed from recovered material from industries or products. They are collected, processed and returned to use in the form of raw materials or products



FR> Le plastique de nos produits est retraité à partir de matériaux récupérés provenant d'industries ou de produits. Ils sont collectés, transformés et retournés pour être utilisés sous forme de matières premières ou de produits

ES> El plástico de nuestros productos está hecho a partir del material sobrante de las industrias o productos, además al final de su vida útil son recolectados, procesados y vuelven a poner en uso en forma de materia prima.

DE> Unsere Produkte bestehen aus recyceltem Kunststoff, das aus der industriellen Produktion oder von entsorgten Gütern stammt. Der Kunststoff wird gesammelt, verarbeitet und in Form von Rohstoffen oder Waren wieder dem Materialkreislauf zugeführt

IT> La plastica dei nostri prodotti viene rielaborata dal recupero di materiale proveniente da industrie o prodotti. Sono raccolti, elaborati e restituiti all'uso, sotto forma di materie prime o prodotti.

2



Plastic designed to degrade under industrial or domestic compost conditions



FR> Plastique conçu pour se décomposer dans des conditions de compost industriel ou domestique

ES> Plástico diseñado para degradarse bajo las condiciones de compostaje industriales o domésticas.

DE> Der Kunststoff ist unter industriellen Bedingungen biologisch abbaubar oder im Haushalt kompostierbar

IT> Plastica progettata per essere degradata in condizioni di compostaggio industriale o domestico.

3

Ⓢ Packaging from recycled cardboard



FR> Emballage à partir de carton recyclé

ES> Envasado a partir de cartón reciclado

DE> Die Verpackungen bestehen aus recycelten Kartonagen

IT> Imballaggio da cartone riciclato

4



THE TOP PRIORITY OF THE MEDIA CLIC BIO ECOLUTIONS® LIFE CYCLE IS SUSTAINABILITY



BIODEGRADABLE PEN:

No ink left in the pen?
No problem, it's compostable.
The barrel is **100% biodegradable** while the clip is **100% recyclable**.

LOW TRANSPORT IMPACT:

Production, printing and even **raw materials made in Europe**

RENEWABLE ENERGY:

Produced in our factory and printing facilities which are both powered with **100% renewable electricity**.

BIO-BASED MATERIAL:

The barrel is made from **70% bio-based material**.
The colourants are **100% bio**.

MADE TO LAST:

- More than **10,000 clicks**
- Unbreakable clip

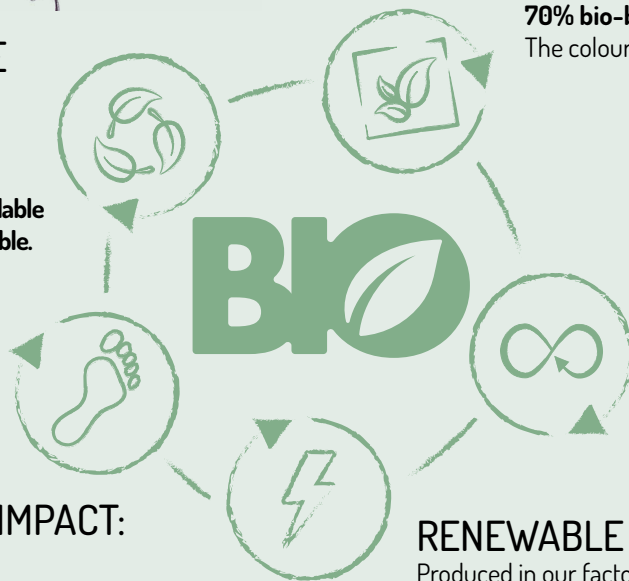

FR> STYLO BIODÉGRADABLE: Plus d'encre dans le stylo? Pas de soucis, celui-ci est décomposable. Le corps est **100% biodégradable** et le clip est **100% recyclable**.

MATERIEL BIO Le corps est fabriqué à partir de **70% de matériel bio**. Les colorants sont **100% bio**.

FABRIQUÉ POUR DURER:
• plus de **10.000 clics**
• Clip incassable.

FAIBLE IMPACT SUR LE TRANSPORT: Production, marquage et **matières premières fabriqués en Europe**.

ENERGIE RENOUVELABLE: Produits dans nos usines et ateliers de marquages tous deux alimentés en **électricité 100% renouvelable**.

ES> BOLÍGRAFO BIODEGRADABLE: ¿No queda tinta en el bolígrafo? No hay problema, es compostable. El cuerpo es **100% biodegradable**, mientras que el clip es **100% reciclable**.

MATERIAL BIO: El cuerpo está hecho el **70% de material bio**. Los colorantes son **100% bio**.

HECHO PARA DURAR:
• Más de **10.000 clics**
• Clip irrompible.

BAJO IMPACTO DE TRANSPORTE: La producción, impresión e incluso las **materias primas son hechas en Europa**.

ENERGÍA RENOVABLE: Producido en nuestra fábrica e instalaciones de impresión, ambas impulsadas con **electricidad 100% renovable**.

DE> BIOLOGISCH ABBAUBARER KUGELSCHREIBER: Ist der Kugelschreiber leer? Kein Problem, denn er ist kompostierbar! Der Schaft ist zu **100% biologisch abbaubar**, der Clip zu **100% recycelbar**.

BIOBASIERTES MATERIAL: Der Schaft besteht zu **70% aus biobasiertem Material**. Die Farbstoffe sind zu **100% natürlich**.

HOHE LEBENSDAUER:
• Mehr als **10.000 Klicks**
• Unzerbrechlicher Clip

GERINGE UMWELTBELASTUNG DURCH KURZE TRANSPORTWEGE: Die Herstellung, **das Bedrucken und selbst die Rohstoffgewinnung erfolgen in Europa**

ERNEUERBARE ENERGIEN: Unsere Produktionsstätten und Druckanlagen werden zu **100% mit erneuerbaren Energien betrieben**.

IT> PENNA BIODEGRADABILE: Non rimane inchiostro nella penna? Nessun problema, è compostabile. Il fusto è al **100% biodegradabile** mentre la clip è al **100% riciclabile**.

MATERIALE BASE BIO: Il fusto è composto al **70% da materiale base bio**. I coloranti sono al **100% bio**.

FATTA PER DURARE:
• Oltre **10.000 click**
• Clip indistruttibile.

BASSO IMPATTO DEL TRASPORTO: Produzione, stampa e **materie prime sono realizzate in Europa**.

ENERGIA RINNOVABILE: L'energia per la produzione e la stampa nelle nostre strutture deriva al **100% da elettricità rinnovabile**.

BIO New!

MADE FROM 70% OF BIO-SOURCED* & 100% BIODEGRADABLE MATERIAL

Made from sugar cane.



MIX & MATCH



BIC MEDIA CLIC BIO
ecolutions
Opaque Ballpen - 1972



01BIO



012BIO



03BIO



05BIO 100%



04BIO



02BIO

Always visible!

Colour ink
Encre de couleur
Color de la tinta
Schreibfarbe
Colore inchiostro



*The percentage is calculated on total weight of barrel, biodegradable under industrial conditions
*Le pourcentage est calculé sur le poids total du corps du style. Biodégradable selon les conditions industrielles exigées
*Porcentaje calculado a partir del peso total del cuerpo del bolígrafo, biodegradable bajo condiciones industriales.
*Der Prozentsatz wird vom Gesamtgewicht des unter industriellen Bedingungen biologisch abbaubaren Schafts berechnet
*La percentuale é calcolata sul peso totale del fusto, biodegradabile in condizioni industriali.

Red Ink available under request
Encre rouge disponible sur demande
Tinta roja bajo consulta
Rote Tinte auf Anfrage erhältlich
Inchiostro rosso disponibile su richiesta

Made from sugar cane.
FR > Fait à partir de canne à sucre.
ES > Hecho a partir de caña de azúcar
DE > Hergestellt auf Basis von Biopolyester, das mit Zuckerrohr produziert wird.
IT > A base di canna da zucchero

MOQ 500u.

Standard colours combination

Combinaison de couleurs standards / Combinación de colores estandard / Standardfarbkombination / Combinazione colori standard

Plug

Bouton / Botón / Endstück / Pulsante

OPAQUE 01 12 10 03 5C 2D 13 84 85 5G 05 3D 83 04 07 18 02 FROSTED 69

Clip

Clip / Clip / Clip / Clip

OPAQUE 01 12 10 03 5C 2D 13 84* 85* 5G 05 3D 83* 04 07 18 02 FROSTED 69

Barrel

Corps / Cuerpo / Schaft / Fusto

OPAQUE 01BIO 02BIO 03BIO 05BIO 04BIO 02BIO

BIC® MEDIA CLIC BIO

ecolutions®

1972

A SP: max. 4 col.

B SP: max. 2 col.

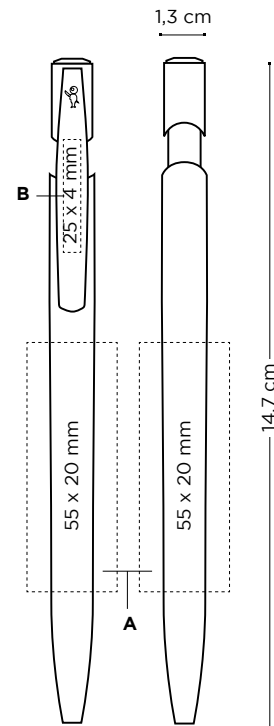

Writing modes:

Mode écriture /
Modos de escritura /
Schreibmodi /
Modalità di scrittura

Ballpen



M

Printing techniques:

Techniques d'impression /
Técnicas de impresión /
Schreibmodi /
Drucktechniken /
Tecniche di stampa



(SP)
SCREEN
PRINTING

New optional special packaging:

Nouvel emballage spécial en option /
Nuevo envasado especial opcional /
Neue optionale Verpackung / Nuove
confezioni speciali opzionali



ECO Sleeve / Plastic Pouch / Window Box

External packaging:

Emballage externe / Envasado
exterior / Außenverpackung /
Imballaggio esterno



500 ± 4,3 Kg



MADE IN
SPAIN



*until stock lasts

Jusqu'à épuisement du stock / Hasta que se acabe el stock
/ Solange der Vorrat reicht / Fino a esaurimento scorte

+ INFO pag. 48

www.bicgraphic.eu

13



MADE FROM 92% OF RECYCLED MATERIAL* & 100% RECYCLABLE

BIC® MEDIA CLIC
ecolutions®
Opaque
Ballpen 1E25
Pencil 1E28



1E

3E



MADE FROM 50% OF RECYCLED MATERIAL* & 100% RECYCLABLE

BIC® MEDIA CLIC GRIP
ecolutions®
Opaque
Ballpen 1E20
Pencil 1E21



01/12

01/03

01/05

01/07

01/02



Made from the scrap of car parts.



*The percentage is calculated on total weight of barrel
*Pourcentage calculé sur le poids total du corps du stylo
*Porcentaje calculado a partir del peso total del cuerpo del bolígrafo
*Der Prozentsatz wird vom gesamten Schaftgewicht berechnet
*La percentuale é calcolata sul peso totale del fusto

**48h not available in Digital finishes
**48h non disponible en impression numérique
**48h no disponible en acabados digitales
**48h bei digitalen Ausführungen nicht erhältlich
**48h non disponibile in finiture digital

Made from the scrap of car parts.
FR > Fabriqué à partir de ferraille de pièces d'automobile
ES > Hecho a partir del sobrante de la fabricación de piezas de automóvil.
DE > Hergestellt auf Basis von Ausschüssen der Fertigung von Autoteilen.
IT > Fabbricato dalla produzione di scarti di componenti di automobili

Digital Printing!

MIX & MATCH



MADE FROM 50% OF RECYCLED MATERIAL* & **100% RECYCLABLE**

BIC® MEDIA CLIC DIGITAL

eColutions®

Opaque
Ballpen 1E25
Pencil 1E28



01



Only available in white barrel
Disponible en corps blanc
Solo disponible en cuerpo blanco
Mit weißem Schaft erhältlich
Disponibile solo in fusto bianco

01



100%

MADE FROM 50% OF RECYCLED MATERIAL* & **100% RECYCLABLE**

BIC® MEDIA CLIC GRIP DIGITAL

eColutions®

Opaque
Ballpen 1E20
Pencil 1E21



01/05



Only available in white barrel
Disponible en corps blanc
Solo disponible en cuerpo blanco
Mit weißem Schaft erhältlich
Disponibile solo in fusto bianco

01/12



100%

MOQ 500u.

Standard colours combination

Combinaison de couleurs standards / Combinación de colores estandar / Standardfarbkombination / Combinazione colori standard **eco**olutions® Standard colours combination

Plug

Bouton / Botón / Endstück / Pulsante



OPAQUE 01 12 10 03 5C 2D 13 84* 85* 5G 05 3D 83* 04 07 18 02 FROSTED 69

Clip

Clip / Clip / Clip / Clip

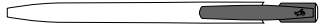

OPAQUE 01 12 10 03 5C 2D 13 84* 85* 5G 05 3D 83* 04 07 18 02 FROSTED 69

Barrel

Corps / Cuerpo / Schaft / Fusto



OPAQUE 1E 3E

Barrel & Grip OPAQUE

01/12 01/03 01/05 01/07 01/02



Add the Möbius loop to your artwork at no additional charge. Please specify it on your order. (Möbius loop imprint defaults to left-hand hand corner.)

FR > Ajoutez la boucle Möbius sur votre BAT sans frais additionnel. Merci de le préciser dans votre bon de commande (en bas à gauche par défaut)

ES > Añade el Möbius loop a tu arte final sin cargo adicional. Por favor asegúrate de especificarlo en tu pedido. (La impresión del Möbius loop a mano izquierda en la esquina).

DE > Auf Wunsch können wir ihre Grafik ohne Zusatzkosten mit einer Möbiusband-Prägung versehen. Bitte geben Sie diesen Wunsch bei der Bestellung an. (Die Möbiusband-Prägung wird standardmäßig in der linken Ecke platziert.)

IT > Aggiungi il Mobius loop alla tua grafica senza costi addizionali. Si prega di specificarlo nell'ordine. La stampa del Mobius loop viene fatta di default per destrorsi nell'angolo destro.

Exact colour match:

Correspondance exacte des couleurs / Color exacto / Exakte Farbübereinstimmung / Esatta corrispondenza di colore

≥ 10.000 units 1E25/1E28
1E20/1E21

≥ 20.000 units 1E20 digital/1E21 digital

Writing modes:

Mode écriture / Modos de escritura
Schreibmodi / Modalità di scrittura

Ballpen

Mechanical pencil



M

MP

*Until stock lasts

Ø0,7mm

Jusqu'à épuisement du stock / Hasta que se acabe el stock
/ Solange der Vorrat reicht / Fino a esaurimento scorte

Printing techniques:

Techniques d'impression / Técnicas de impresión
Drucktechniken / Tecniche di stampa



(SP)
SCREEN
PRINTING

(DG)
DIGITAL

Decoration:

Personnalisation / Personalización
Dekoration / Decorazione

BIC® MEDIA CLIC

©©olutions® 1E25 (ballpen)
©©olutions® 1E28 (pencil)

A SP: max. 4 col.

B SP: max. 2 col.

C DG: full-colour

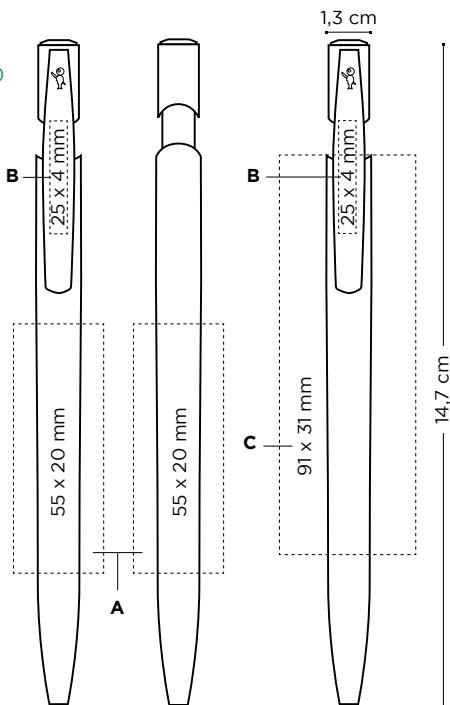

BIC® MEDIA CLIC GRIP

©©olutions® 1E20 (ballpen)
©©olutions® 1E21 (pencil)

D SP: max. 4 col.

E SP: max. 2 col.

F DG: full-colour

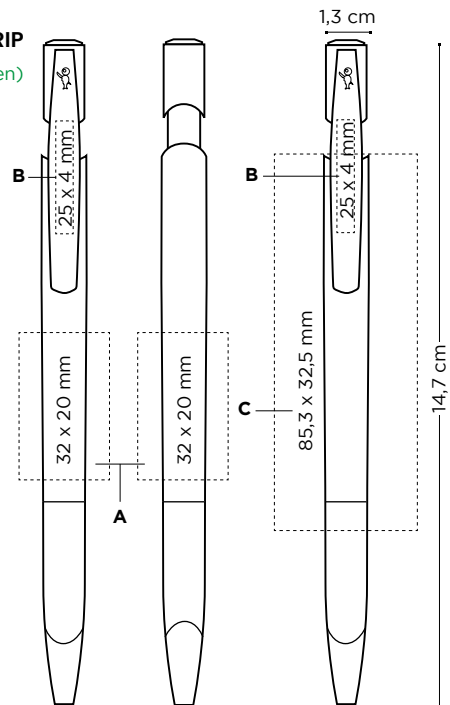

External packaging:

Emballage externe / Envasado exterior / Außenverpackung / Imballaggio esterno



500 ± 4,1 Kg

New optional special packaging:

Nouvel emballage spécial en option / Nuevo envasado especial opcional / Neue optionale Verpackung / Nuove confezioni speciali opzionali

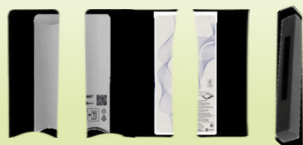

ECO Sleeve / Plastic Pouch / Window Box

External packaging:

Emballage externe / Envasado exterior / Außenverpackung / Imballaggio esterno



500 ± 4,3 Kg

Check out the video

Regardez la video / Mira el video / Produktvideo / Guarda il video.



MADE IN SPAIN





MADE FROM 94% OF RECYCLED MATERIAL* & 100% RECYCLABLE



MIX & MATCH



Digital Printing!

BIC® ROUND STIC® ecolutions®
Opaque - 1E10



BIC® ROUND STIC® ecolutions®
Frosted - 1E10



BIC® ROUND STIC® DIGITAL ecolutions®
Opaque - 1E10



*The percentage is calculated on total weight of product excluding cartridge
 *Pourcentage calculé sur le poids total du produit en excluant le cartouche
 *Porcentaje calculado a partir del peso total del producto excluyendo el cartucho
 *Der Prozentsatz bezieht sich auf das Gesamtgewicht des Produkts ohne Patrone
 *La percentuale é calcolata sul peso totale del prodotto refill escluso

**48h not available in Digital finishes
 **48h non disponibile in impression numérique
 **48h no disponibile en acabados digitales
 **48h bei digitalen Ausführungen nicht erhältlich
 **48h non disponibile in finiture digital

Made from the scrap of fruit and vegetable trays.
 FR > Fabriqué à partir de déchets de fruits et légumes
 ES > Hecho a partir del sobrante de la fabricación de bandejas de frutas y verduras.
 DE > Hergestellt auf Basis von Ausschüssen produzierter Verpackungen für Obst und Gemüse.
 IT > Fabbriato dalla produzione di scarti di vassoi di frutta e verdura.

MOQ 500u.

ecolutions® Standard colours combination

Combinaison de couleurs standards / Combinación de colores estandard
Standardfarbkombination / Combinazione colori standard

Plug

Bouton / Botón / Endstück / Pulsante

8E 7E 10E 3E

Clip

Clip / Clip / Clip / Clip



8E 7E 10E 3E

Section

Section / Sección / Teil / Sezione



8E 7E 10E 3E

Barrel

Corps / Cuerpo / Schaft / Fusto

OPAQUE FROSTED

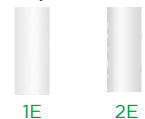

1E 2E

Exact colour match:

Correspondance exacte des couleurs / Color exacto /
Exakte Farbübereinstimmung / Esatta corrispondenza di colore

≥ 10.000 units



Add the Möbius loop to your artwork at no additional charge. Please specify it on your order. (Möbius loop imprint defaults to left-hand hand corner.)

FR > Ajoutez la boucle Möbius sur votre BAT sans frais additionnel. Merci de le préciser dans votre bon de commande (en bas à gauche par défaut)

ES > Añade el Möbius loop a tu arte final sin cargo adicional. Por favor asegúrate de especificarlo en tu pedido. (La impresión del Möbius loop a mano izquierda en la esquina).

DE > Auf Wunsch können wir ihre Grafik ohne Zusatzkosten mit einer Möbiusband-Prägung versehen. Bitte geben Sie diesen Wunsch bei der Bestellung an. (Die Möbiusband-Prägung wird standardmäßig in der linken Ecke platziert.)

IT > Aggiungi il Möbius loop alla tua grafica senza costi addizionali. Si prega di specificarlo nell'ordine. La stampa del Möbius loop viene fatta di default per destrorsi nell'angolo destro.

Decoration:

Personalisation
Personalización
Dekoration
Decorazione

BIC® ROUND STIC®

ecolutions® 1E10

A SP: max. 3 col.

B SP: max. 1 col.

C DG: full-colour

(available in white barrel) disponible en corps blanc / disponible en cuerpo blanco / mit weißem schaft erhältlich / disponibile in fusto bianco

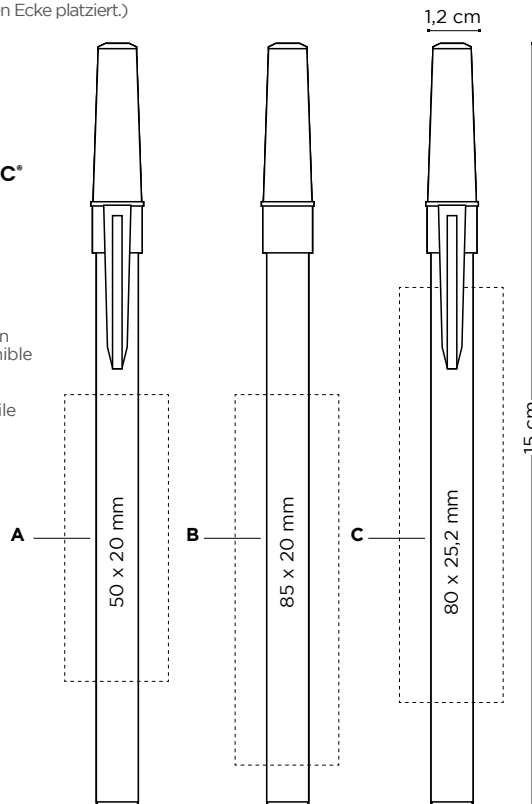

Writing modes:

Mode écriture / Modos de escritura
Schreibmodi / Modalità di scrittura

Ballpen



M

Printing techniques:

Techniques d'impression / Técnicas de impresión / Drucktechniken /
Tecniche di stampa



(SP)
SCREEN
PRINTING



(DG)
DIGITAL

New optional special packaging:

Nouvel emballage spécial en option / Nuevo
envasado especial opcional / Neue optionale
Verpackung / Nuove confezioni speciali opzionali

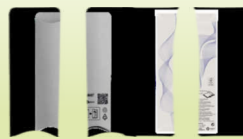

ECO Sleeve / Plastic Pouch

External packaging:

Emballage externe / Envasado
exterior / Außenverpackung /
Imballaggio esterno



500 ± 2,5 Kg



MADE IN
SPAIN



MADE FROM 78% OF RECYCLED MATERIAL* & 100% RECYCLABLE



Made from the scrap of fruit and vegetable trays.



Digital Printing!

BIC® CLIC STIC
ecolutions®
Opaque - 1E00



BIC® CLIC STIC
ecolutions®
Frosted - 1E00



BIC® CLIC STIC
DIGITAL
Opaque
1E00



*The percentage is calculated on total weight of product excluding cartridge and spring

* Le pourcentage est calculé sur le poids total du produit hors cartouche et ressort

*El porcentaje esta calculado sobre el peso total del producto excluyendo el cartucho y el muelle.

*Der Prozentsatz bezieht sich auf das Gesamtgewicht des Produkts ohne Patrone und Feder

*La percentuale viene calcolata sul peso totale del prodotto esclusi cartuccia e molla

**48h not available in Digital finishes

**48h non disponibile in impression numérique

**48h no disponible en acabados digitales

**48h bei digitalen Ausführungen nicht erhältlich

**48h non disponibile in finiture digital

Made from the scrap of fruit and vegetable trays.

FR > Fabriqué à partir de déchets de fruits et légumes

ES > Hecho a partir del sobrante de la fabricación de bandejas de frutas y verduras.

DE > Hergestellt auf Basis von Ausschüssen produzierter Verpackungen für Obst und Gemüse.

IT > Fabbriato dalla produzione di scarti di vassoi di frutta e verdura.

MOQ 500u.

©©olutions® Standard colours combination

Combinaison de couleurs standards / Combinación de colores estandar
Standardfarbkombination / Combinazione colori standard

Plug

Bouton / Botón / Endstück / Pulsante

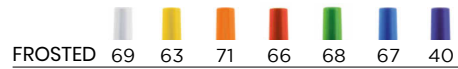

Clip

Clip / Clip / Clip / Clip

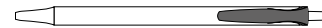

OPAQUE 8E 7E 10E 3E

Section

Section / Sección / Teil / Sezione



OPAQUE 8E 7E 10E 3E

Barrel

Corps / Cuerpo / Schaft / Fusto



OPAQUE 1E FROSTED 2E

Exact colour match:

Correspondance exacte des couleurs / Color exacto /
Exakte Farbübereinstimmung / Esatta corrispondenza di colore

≥ 10.000 units



Add the Möbius loop to your artwork at no additional charge. Please specify it on your order. (Möbius loop imprint defaults to left-hand hand corner.)

FR > Ajoutez la boucle Möbius sur votre BAT sans frais additionnel. Merci de le préciser dans votre bon de commande (en bas à gauche par défaut)

ES > Añade el Möbius loop a tu arte final sin cargo adicional. Por favor asegúrate de especificarlo en tu pedido. (La impresión del Möbius loop a mano izquierda en la esquina).

DE > Auf Wunsch können wir ihre Grafik ohne Zusatzkosten mit einer Möbiusband-Prägung versehen. Bitte geben Sie diesen Wunsch bei der Bestellung an. (Die Möbiusband-Prägung wird standardmäßig in der linken Ecke platziert.)

IT > Aggiungi il Mobius loop alla tua grafica senza costi addizionali. Si prega di specificarlo nell'ordine. La stampa del Mobius loop viene fatta di default per destrorsi nell'angolo destro.

Decoration:

Personalisation
Personalización
Dekoration
Decorazione

BIC® CLIC STIC

©©olutions® 1E00

A SP: max. 3 col.

B SP: max. 1 col.

C SP: max. 2 col.

D DG: full-colour (area for text)
(available in white barrel)

E DG: full-colour (area for images)
(available in white barrel)

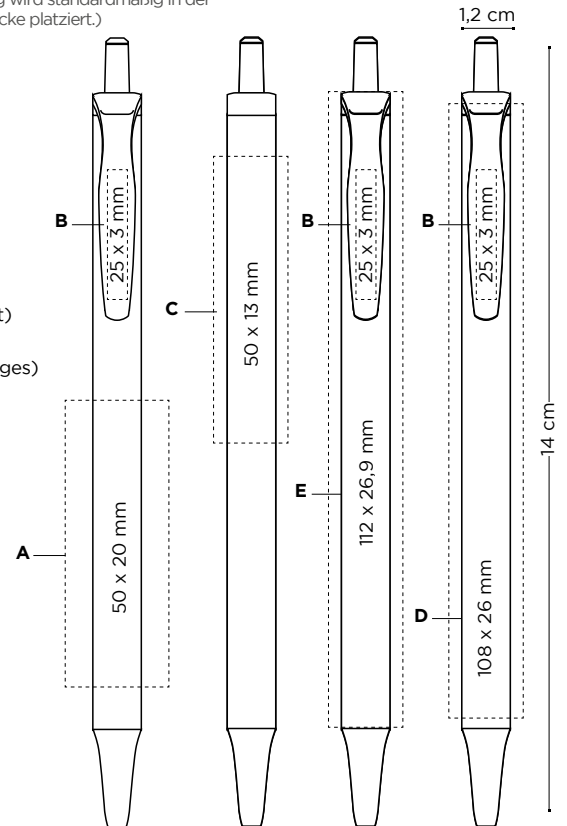

Writing modes:

Mode écriture / Modos de escritura
Schreibmodi / Modalità di scrittura

Ballpen



M

Printing techniques:

Techniques d'impression / Técnicas de impresión / Drucktechniken /
Tecniche di stampa



(SP)
SCREEN
PRINTING



(DG)
DIGITAL

New optional special packaging:

Nouvel emballage spécial en option / Nuevo
envasado especial opcional / Neue optionale
Verpackung / Nuove confezioni speciali opzionali



ECO Sleeve / Plastic Pouch

External packaging:

Emballage externe / Envasado
exterior / Außenverpackung /
Imballaggio esterno



500 ± 2,9 Kg



MADE IN
SPAIN



MADE FROM 83% OF RECYCLED MATERIAL* & 100% RECYCLABLE

Made from the scrap of car parts.



BIC® SUPER CLIP
ecolutions®
Opaque
1E50



MOQ 500u.

ecolutions® Standard colours combination

Combinaison de couleurs standards / Combinación de colores estandard
Standardfarbkombination / Combinazione colori standard



01



1E

Exact colour match:

Correspondance exacte des couleurs / Color exacto / Exakte Farbübereinstimmung / Esatta corrispondenza di colore

≥ 10.000 units



Add the Möbius loop to your artwork at no additional charge. Please specify it on your order. (Möbius loop imprint defaults to left-hand hand corner.)

FR > Ajoutez la boucle Möbius sur votre BAT sans frais additionnel. Merci de le préciser dans votre bon de commande (en bas à gauche par défaut)

ES > Añade el Möbius loop a tu arte final sin cargo adicional. Por favor asegúrate de especificarlo en tu pedido. (La impresión del Möbius loop a mano izquierda en la esquina).

DE > Auf Wunsch können wir ihre Grafik ohne Zusatzkosten mit einer Möbiusband-Prägung versehen. Bitte geben Sie diesen Wunsch bei der Bestellung an. (Die Möbiusband-Prägung wird standardmäßig in der linken Ecke platziert.)

IT > Aggiungi il Mobius loop alla tua grafica senza costi addizionali. Si prega di specificarlo nell'ordine. La stampa del Mobius loop viene fatta di default per destrorsi nell'angolo destro.

*The percentage is calculated on total weight of product excluding cartridge and spring

* Le pourcentage est calculé sur le poids total du produit hors cartouche et ressort

*El porcentaje esta calculado sobre el peso total del producto excluyendo el cartucho y el muelle.

*Der Prozentsatz bezieht sich auf das Gesamtgewicht des Produkts ohne Patrone und Feder

*La percentuale viene calcolata sul peso totale del prodotto esclusi cartuccia e molla

**48h not available in Digital finishes

**48h non disponible en impresion numérique

**48h no disponible en acabados digitales

**48h bei digitalen Ausführungen nicht erhältlich

**48h non disponibile in finiture digital

Made from the scrap of car parts.

FR > Fabriqué à partir de ferraille de pièces d'automobile

ES > Hecho a partir del sobrante de la fabricación de piezas de automóvil.

DE > Hergestellt auf Basis von Ausschüssen der Fertigung von Autoteilen.

IT > Fabbriato dalla produzione di scarti di componenti di automobili

Decoration:

Personalisation
Personalización
Dekoration
Decorazione

BIC® SUPER CLIP

1039

©COLutions® 1E50

A SP: max. 2 col.

B SP: max. 1 col.

C DG: full-colour

D BP: full-colour

BP Texture: full-colour

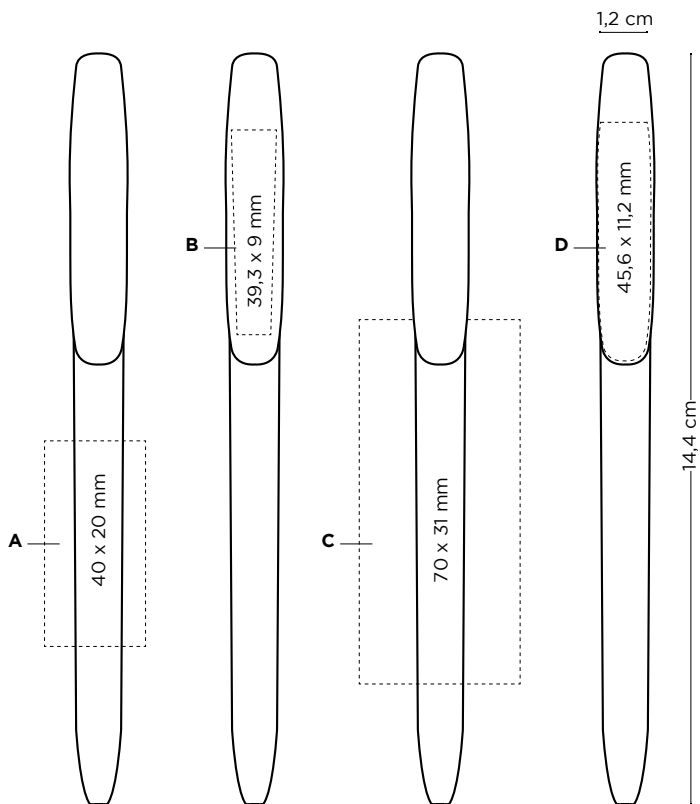

Writing modes:

Mode écriture / Modos de escritura
Schreibmodi / Modalità di scrittura

Ballpen



M

Printing techniques:

Techniques d'impression / Técnicas de impresión / Drucktechniken /
Tecniche di stampa



(SP)
SCREEN
PRINTING



(DG)
DIGITAL



(BP) britePix™



New optional special packaging:

Nouvel emballage spécial en option / Nuevo
envasado especial opcional / Neue optionale
Verpackung / Nuove confezioni speciali opzionali

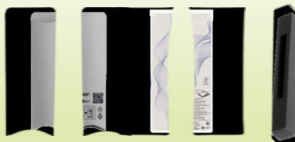

ECO Sleeve / Plastic Pouch / Window Box

+ INFO pag. 48

External packaging:

Emballage externe / Envasado
exterior / Außenverpackung /
Imballaggio esterno



250 ± 2,6 Kg



MADE IN
SPAIN



MADE FROM 94% OF RECYCLED MATERIAL* & 100% RECYCLABLE

Made from the scrap of fruit and vegetable trays.



MIX & MATCH



Digital Printing!

BIC® WIDE BODY™
ecolutions®
Opaque - 1E80



1E



BIC® WIDE BODY™
DIGITAL
Opaque
1E80



03



*The percentage is calculated on total weight of barrel

**48h non disponible en impression numérique

*Porcentaje calculado a partir del peso total del cuerpo del bolígrafo

*Der Prozentsatz wird vom gesamten Schaftgewicht berechnet

*La percentuale é calcolata sul peso totale del fusto.

**48h not available in Digital finishes

**48h non disponible en acabados digitales

**48h bei digitalen Ausführungen nicht erhältlich

**48h non disponibile in finiture digital

Made from the scrap of fruit and vegetable trays.

FR > Fabriqué à partir de déchets de fruits et légumes

ES > Hecho a partir del sobrante de la fabricación de bandejas de frutas y verduras.

DE > Hergestellt auf Basis von Ausschüssen produzierter Verpackungen für Obst und Gemüse.

IT > Fabbriato dalla produzione di scarti di vassoi di frutta e verdura.

MOQ 250u.

ecolutions® Standard colours combination
 Combinaison de couleurs standards / Combinación de colores estándar / Standardfarbcombination / Combinazione colori standard

Plug

Bouton / Botón / Endstück / Pulsante

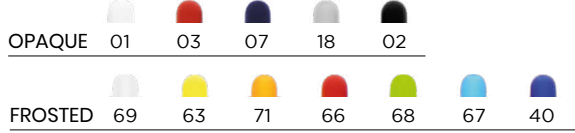

Clip

Clip / Clip / Clip / Clip

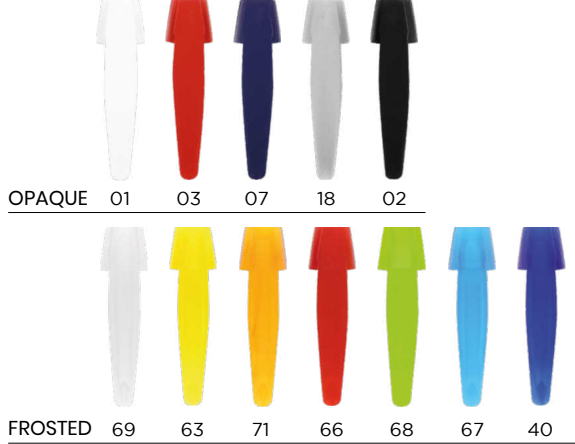

Barrel

Corps / Cuerpo / Schaft / Fusto



Section

Section / Sección / Teil / Sezione

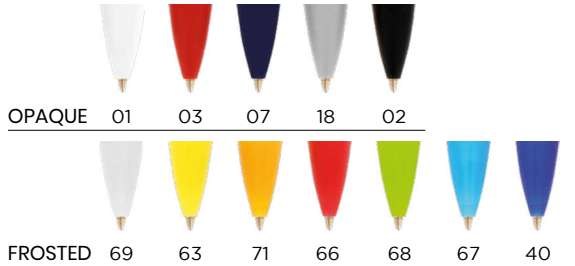

Exact colour match:

≥ 10.000 units ≥ 25.000 units for custom made Section

Writing modes:

Mode écriture / Modos de escritura
 Schreibmodi / Modalità di scrittura

Ballpen



M

Printing techniques:

Techniques d'impression / Técnicas de impresión / Drucktechniken / Tecniche di stampa



(SP)
 SCREEN
 PRINTING



(DG)
 DIGITAL



Add the Möbius loop to your artwork at no additional charge. Please specify it on your order. (Möbius loop imprint defaults to left-hand hand corner.)

FR > Ajoutez la boucle Möbius sur votre BAT sans frais additionnel. Merci de le préciser dans votre bon de commande (en bas à gauche par défaut)

ES > Añade el Möbius loop a tu arte final sin cargo adicional. Por favor asegúrate de especificarlo en tu pedido. (La impresión del Möbius loop a mano izquierda en la esquina).

DE > Auf Wunsch können wir ihre Grafik ohne Zusatzkosten mit einer Möbiusband-Prägung versehen. Bitte geben Sie diesen Wunsch bei der Bestellung an. (Die Möbiusband-Prägung wird standardmäßig in der linken Ecke platziert.)

IT > Aggiungi il Mobius loop alla tua grafica senza costi addizionali. Si prega di specificarlo nell'ordine. La stampa del Mobius loop viene fatta di default per destrorsi nell'angolo destro.

Decoration:

Personalisation
 Personalización
 Dekoration
 Decorazione

BIC® WIDE BODY™

ecolutions® 1E80

A/C SP: max. 2 col.

B/F SP: max. 1 col.

D DG: full-colour (area for images)

E DG: full-colour (area for text)

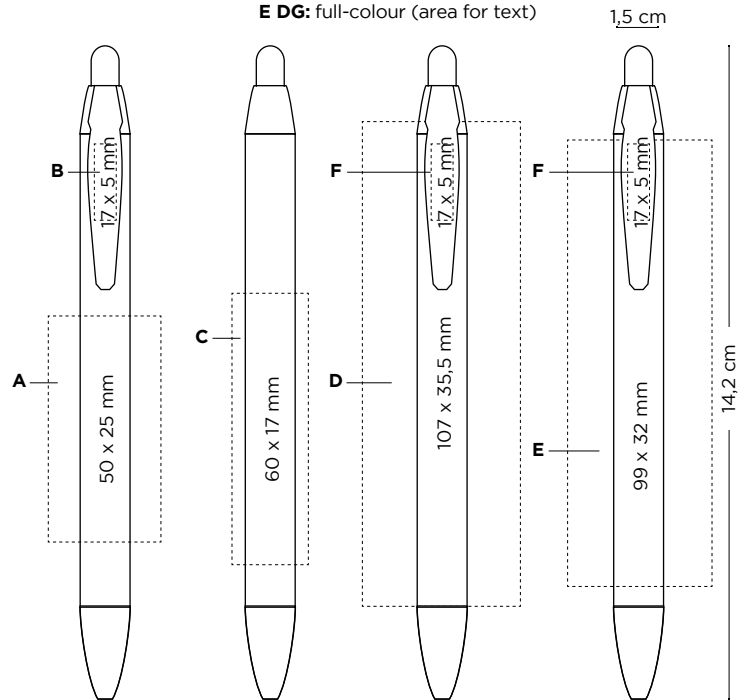

New optional special packaging:

Nouvel emballage spécial en option / Nuevo envasado especial opcional / Neue optionale Verpackung / Nuove confezioni speciali opzionali



ECO Sleeve / Plastic Pouch / Window Box
 + INFO pag. 48

External packaging:

Emballage externe / Envasado exterior / Außenverpackung / Imballaggio esterno



250 ± 2,6 Kg



MADE IN
 SPAIN

www.bicgraphic.eu

25



MADE FROM 65% OF RECYCLED MATERIAL* & 100% RECYCLABLE

Made from pharmaceutical waste.



BIC® MATIC®
ecolutions®
Opaque - 1E40



01/01



12/12



03/03



59/8C 100%



04/8C



07/07



06/8C



02/02

*The percentage is calculated on total weight of the product
 *Pourcentage calculé sur le poids total du produit
 *Porcentaje calculado a partir del peso total del producto
 *Der Prozentsatz ist auf der Grundlage des Gesamtgewichts des Produkts berechnet.
 *La percentuale è calcolata sul peso totale del prodotto.

Made from pharmaceutical waste.
 FR > Fabriqué à partir de déchets pharmaceutiques
 ES > Hecho a partir de desechos farmacéuticos.
 DE > Hergestellt auf Basis von pharmazeutischen Ausschüssen.
 IT > Fabbriato da scarti di farmaci



Add the Möbius loop to your artwork at no additional charge. Please specify it on your order. (Möbius loop imprint defaults to left-hand hand corner.)

FR > Ajoutez la boucle Möbius sur votre BAT sans frais additionnel. Merci de le préciser dans votre bon de commande (en bas à gauche par défaut)

DE > Auf Wunsch können wir ihre Grafik ohne Zusatzkosten mit einer Möbiusband-Prägung versehen. Bitte geben Sie diesen Wunsch bei der Bestellung an. (Die Möbiusband-Prägung wird standardmäßig in der linken Ecke platziert.)

ES > Añade el Möbius loop a tu arte final sin cargo adicional. Por favor asegúrate de especificarlo en tu pedido. (La impresión del Möbius loop a mano izquierda en la esquina).

IT > Aggiungi il Mobius loop alla tua grafica senza costi addizionali. Si prega di specificarlo nell'ordine. La stampa del Mobius loop viene fatta di default per destrorsi nell'angolo destro.

MOQ 500u.

Decoration:

Personnalisation
Personalización
Dekoration
Decorazione

BIC® MATIC®

ecoSolutions® 1E40

A SP: max. 1 col. (not available for BIC® Matic® Quartz)

B/C SP: max. 2 col.

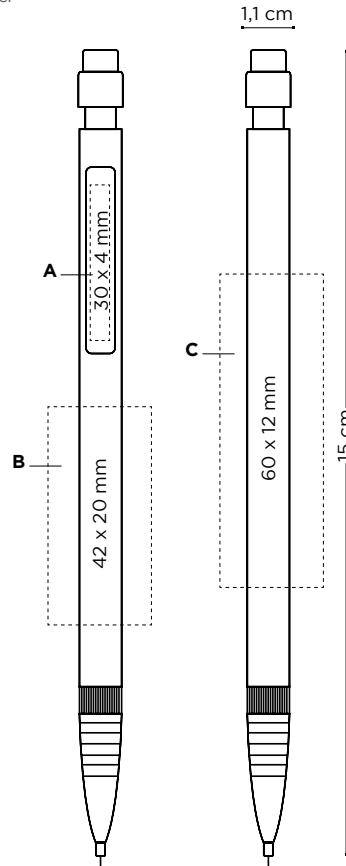

Writing modes:

Mode écriture / Modos de escritura
Schreibmodi / Modalità di scrittura

Mechanical pencil



MP
Ø0,7mm

Printing techniques:

Techniques d'impression / Técnicas de impresión / Drucktechniken / Tecniche di stampa



(SP)
SCREEN PRINTING

New optional special packaging:

Nouvel emballage spécial en option / Nuevo envasado especial opcional / Neue optionale Verpackung / Nuove confezioni speciali opzionali



ECO Sleeve / Plastic Pouch

External packaging:

Emballage externe / Envasado exterior / Außenverpackung / Imballaggio esterno



500 ± 3,1 Kg



MADE IN FRANCE

Digital Printing!



MADE FROM 54% OF RECYCLED MATERIAL*



MADE FROM 46% OF RECYCLED MATERIAL*

DIGITAL
Graphite pencil
cut end - 1150



01

METALLIC DIGITAL
Graphite pencil
cut end - 1962



47

DIGITAL
Graphic pencil
with eraser - 1151

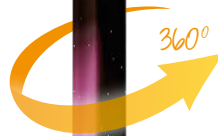

01

METALLIC DIGITAL
Graphic pencil
with eraser - 1960



47

MOQ 500u.

MIX & MATCH



Standard colours combination
 Combinaison de couleurs standards / Combinación de colores estandar /
 Standardfarbkombination / Combinazione colori standard.

Eraser

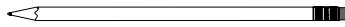

OPAQUE 01 COLOUR CONNECTION 01 12 10 14 59 07 02

Ferrule



OPAQUE 47 26 2C 34 02

Barrel



OPAQUE 01 03 04 20 02

Metallic



OPAQUE 47 26

GRAPHITE PENCIL CUT END:

MADE FROM 54% OF RECYCLED MATERIAL*

*The percentage is calculated on total weight of the product
 *Pourcentage calculé sur le poids total du produit
 *Porcentaje calculado a partir del peso total del producto
 *Der Prozentsatz ist auf der Grundlage des Gesamtgewichts des Produkts berechnet.
 *La percentuale é calcolata sul peso totale del prodotto.

Made from recycled fridges and yogurt pots.

FR > Fabriqué à partir de réfrigérateurs recyclés et de pots de yaourts usagers
 ES > Hecho a partir de neveras recicladas y del material sobrante de la fabricación de envases de yogurt.
 DE > Hergestellt auf Basis von recycelten Kühlschränken und Restmaterial der Fertigung von Joghurtbechern.
 IT > Fabbriato da scarti di frigoriferi riciclati e dal materiale in eccesso della produzione di vasetti di yogurt



Add the Möbius loop to your artwork at no additional charge. Please specify it on your order. (Möbius loop imprint defaults to left-hand hand corner.)

FR > Ajoutez la boucle Möbius sur votre BAT sans frais additionnel. Merci de le préciser dans votre bon de commande (en bas à gauche par défaut)

DE > Auf Wunsch können wir ihre Grafik ohne Zusatzkosten mit einer Möbiusband-Prägung versehen. Bitte geben Sie diesen Wunsch bei der Bestellung an. (Die Möbiusband-Prägung wird standardmäßig in der linken Ecke platziert.)

ES > Añade el Möbius loop a tu arte final sin cargo adicional. Por favor asegúrate de especificarlo en tu pedido. (La impresión del Möbius loop a mano izquierda en la esquina).
 IT > Aggiungi il Mobius loop alla tua grafica senza costi addizionali. Si prega di specificarlo nell'ordine. La stampa del Mobius loop viene fatta di default per destrorsi nell'angolo destro.

Writing modes:

Mode écriture / Modos de escritura
 Schreibmodi / Modalità di scrittura



PC
 HB Ø 2,3mm

Printing techniques:

Techniques d'impression / Técnicas de impresión / Drucktechniken /
 Tecniche di stampa



(SP)
 SCREEN
 PRINTING



(DG)
 DIGITAL

New optional special packaging:

Nouvel emballage spécial en option / Nuevo
 envasado especial opcional / Neue optionale
 Verpackung / Nuove confezioni speciali opzionali



Plastic Pouch
 x3 units

+ INFO pag. 48

External packaging:

Emballage externe / Envasado
 exterior / Außenverpackung /
 Imballaggio esterno



500 ± 3,5 Kg



MADE IN FRANCE

BIC® EVOLUTION® ecolutions®
 PENCIL WITH CUT END
 1150

BIC® EVOLUTION® ecolutions®
 PENCIL WITH ERASER
 1151

A SP: max. 1 col.
B SP: max. 2 col.

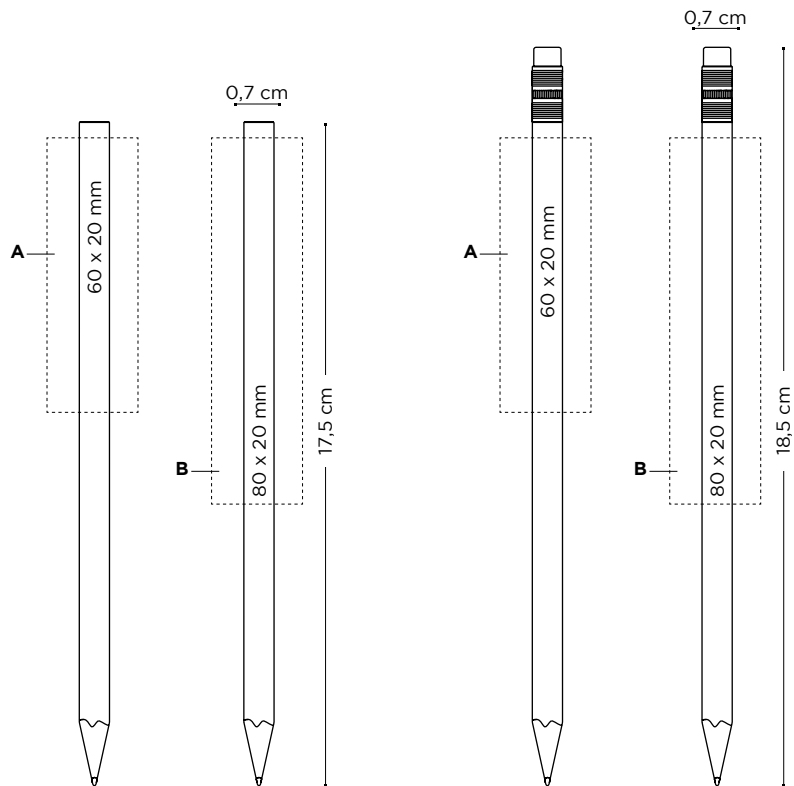

External packaging:

Emballage externe / Envasado exterior /
 Außenverpackung / Imballaggio esterno di stampa.



500 ± 3,5 Kg



MADE IN FRANCE

BIC® EVOLUTION® eColutions®
 PENCIL WITH CUT END
 1150 Digital
 1962 Metallic Digital

BIC® EVOLUTION® eColutions®
 PENCIL WITH ERASER DIGITAL
 1151
 PENCIL WITH ERASER
 METALLIC DIGITAL
 1960

A DG: full-colour (area for images)
B DG: full-colour (area for text)

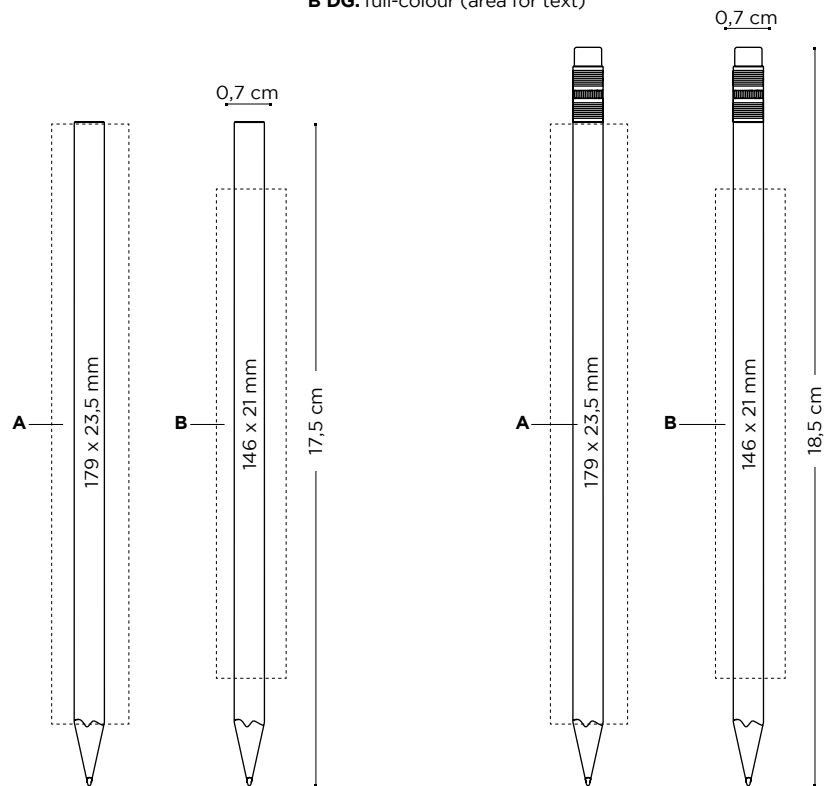

Now you can have it on set!

New optional special packaging:

Nouvel emballage spécial en option / Nuevo envasado especial opcional / Neue optionale Verpackung / Nuove confezioni speciali opzionali



Plastic Pouch (x3 units)
 + INFO pag. 48

External packaging:

Emballage externe / Envasado exterior / Außenverpackung / Imballaggio esterno di stampa.



MADE IN FRANCE

53062



53070



New! 1 plantable pencil - 4 colours!
Combine options!

1. Choose between 10 different seeds
2. Customize your pencil
3. Add a card with planting instructions

FR> Combinez ces options! 1. Choisissez entre les graines différentes 2. Personnalisez votre crayon 3. Ajoutez le carton avec le mode d'emploi

ES> Combina opciones! 1. Escoge entre 10 semillas diferentes. 2. Personaliza tu lápiz 3. Añade una tarjeta con las instrucciones para plantar.

DE> 1. Wählen Sie aus zehn verschiedenen Samensorten 2. Personalisieren Sie Ihren Bleistift 3. Fügen Sie eine Karte mit einer Pflanzanleitung hinzu

IT> Combina le opzioni! 1. Scegli tra 10 semi differenti 2. Personalizza la tua matita 3. Aggiungi il cartoncino con le istruzioni per piantare

standard cardboard

customizable cardboard



Standard barrel



Customized barrel

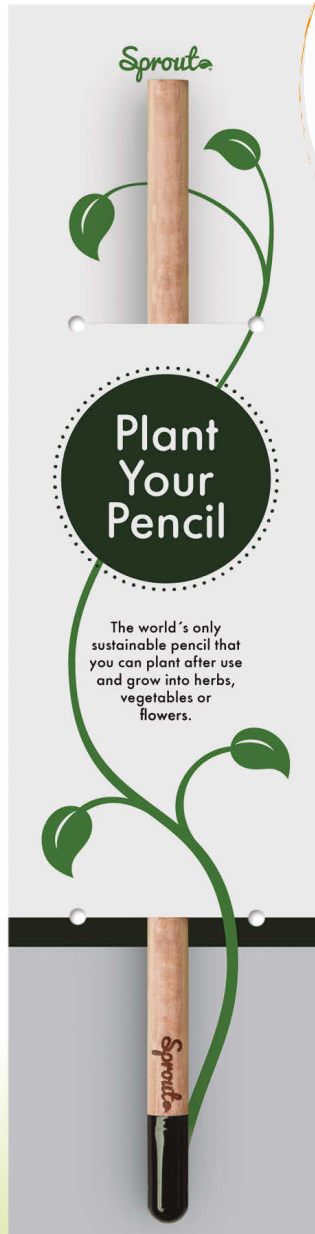

Standard cardboard packaging
Emballage non personnalisé / Cartón no personalizable / Pappe kann nicht angepasst werden / Cartone non personalizzabile.



back



Personalised cardboard packaging
Emballage personnalisable / Cartón personalizable / Pappe kann an Kundenwünsche angepasst werden! / Cartone personalizzabile!

80%



MOQ 500
MOQ 1000 (Pencil + personalised cardboard packaging)

Decoration:

Personnalisation / Personalización / Dekoration / Decorazione.

SPROUT™ PENCIL

53062 / 53070

A LE

B DG: 4-colour process

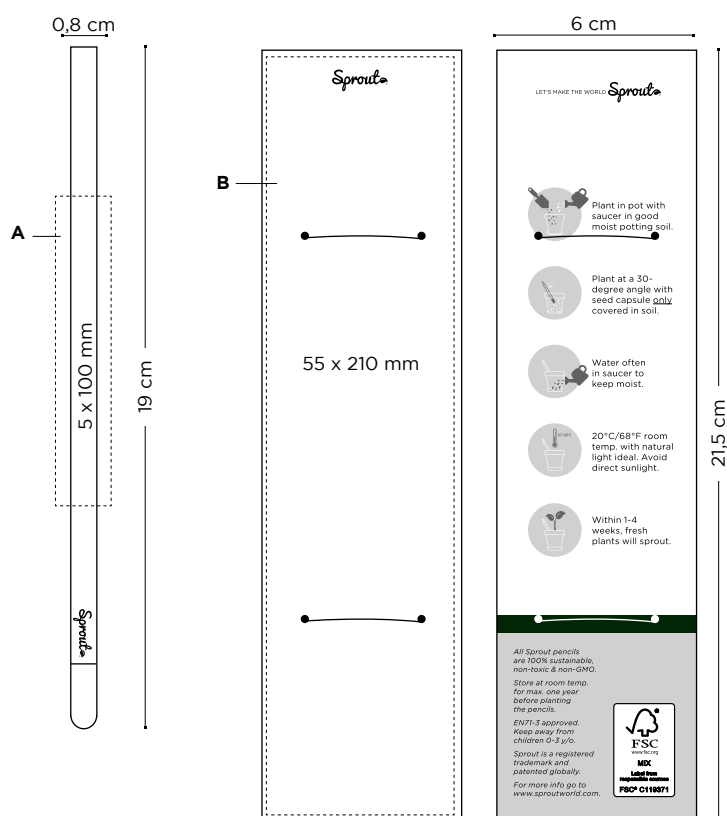

Plant instructions included on the back side. For customized cardboard, you can change the font and colours!

Mode d'emploi inclus au dos Pour un carton personnalisé, vous pouvez changer la police et les couleurs

Instrucciones para plantar incluidas en el parte de atrás. Para personalizar el cartón, se pueden cambiar la fuente y los colores!

Mit Pflanzanleitung auf der Rückseite. Schriftart und Farben sind beim individuell gestaltbaren Karton anpassbar!

Istruzioni per piantare incluse sul retro. Possibilità di personalizzare il cartoncino cambiando caratteri e colori!

Writing modes:

Mode écriture / Modos de escritura / Schreibmodi / Modalità di scrittura



PC
 HB Ø 2,3mm

Printing techniques:

Techniques d'impression / Técnicas de impresión / Drucktechniken / Tecniche di stampa



(DG)
 DIGITAL



(LE)
 LASER

External packaging:

Emballage externe / Envasado exterior / Außenverpackung / Imballaggio esterno



500 ± 2,5 Kg Only pencil
 ± 5 Kg with cardboard packaging

Packaging:

Emballage / Envasado / Verpackung / Imballaggio.



Check out the video

Regardez la video / Mira el video / Produktvideo / Guarda il video.





MADE FROM 51% OF RECYCLED MATERIAL* & 100% RECYCLABLE

Made from pharmaceutical waste.



BIC PERMANENT MARKER **ecolutions**
1210



02

Colour ink
Encre de couleur
Color de la tinta
Schreibfarbe
Colore inchiostro



02

100%

*The percentage is calculated on total weight of product excluding ink system

* Le pourcentage est calculé sur le poids total du produit hors cartouche

*El porcentaje está calculado sobre el peso total del producto excluyendo el cartucho

*Der Prozentsatz bezieht sich auf das Gesamtgewicht ohne den Tintenmechanismus

*la percentuale viene calcolata sul peso totale del prodotto escluso il sistema d'inchiostro

Made from pharmaceutical waste.

FR > Fabriqué à partir de déchets pharmaceutiques

ES > Hecho a partir de desechos farmacéuticos.

DE > Hergestellt auf Basis von pharmazeutischen Ausschüssen.

IT > Fabbriato da scarti di farmaci



Add the Möbius loop to your artwork at no additional charge. Please specify it on your order. (Möbius loop imprint defaults to left-hand hand corner.)

FR > Ajoutez la boucle Möbius sur votre BAT sans frais additionnel. Merci de le préciser dans votre bon de commande (en bas à gauche par défaut)

DE > Auf Wunsch können wir ihre Grafik ohne Zusatzkosten mit einer Möbiusband-Prägung versehen. Bitte geben Sie diesen Wunsch bei der Bestellung an. (Die Möbiusband-Prägung wird standardmäßig in der linken Ecke platziert.)

ES > Añade el Möbius loop a tu arte final sin cargo adicional. Por favor asegúrate de especificarlo en tu pedido. (La impresión del Möbius loop a mano izquierda en la esquina).

IT > Aggiungi il Mobius loop alla tua grafica senza costi addizionali. Si prega di specificarlo nell'ordine. La stampa del Mobius loop viene fatta di default per destrorsi nell'angolo destro.

MOQ 250u.

Decoration:

Personalisation / Personalización
Dekoration / Decorazione.

**BIC® PERMANENT
MARKER eColutions®**

1210

A SP: max. 1 col.

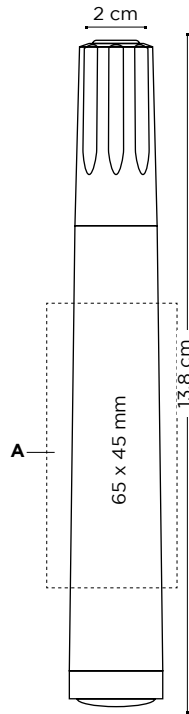

eColutions® **Made with 51% recycled material.**

Writing modes:

Mode écriture / Modos de escritura
Schreibmodi / Modalità di scrittura

Marker



MK

Printing techniques:

Techniques d'impression / Técnicas de impresión / Drucktechniken /
Tecniche di stampa



(SP)
SCREEN
PRINTING

External packaging:

Emballage externe / Envasado exterior / Außenverpackung /
Imballaggio esterno



250 ± 2,6 Kg



**MADE IN
FRANCE**



50 MM X 75 MM ADHESIVE NOTEPADS @COlutions®

MADE OF 100% RECYCLED FIBRE*
& 100% RECYCLABLE



Ideal pocket size
for mailing campaigns!

Decoration:

**BIC® 50 MM X 75 MM
ADHESIVE NOTEPADS**
A DG: 4-colour process

MOQ 500u.

- 25 @COlutions® 3520
- 50 @COlutions® 3550
- 100 @COlutions® 3580

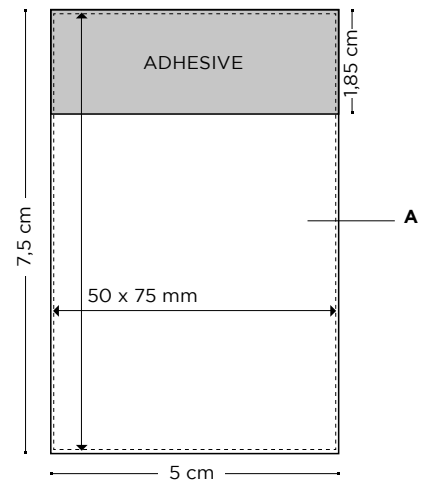

External Packaging:



1000 ± 8,7 Kg
 25



500 ± 8,5 Kg
 50



250 ± 8,4 Kg
 100

Exact colour match:

Correspondance exacte des couleurs / Color exacto / Exakte Farbübereinstimmung / Esatta corrispondenza di colore.

≥ 500 units

Paper type:

Type de papier / Tipo de papel / Papierart / Tipo carta.

Recycled 80g

Special packaging:

Emballage spécial / Envasado especial / Preis auf Anfrage / Confezione speciale.

shrink-wrapped

N° Sheets	Units per pack
25	10
50	5
100	1

Optional Packaging:
Cello Wrap 1, 2, 3 units

Printing techniques:

Techniques d'impression / Técnicas de impresión / Drucktechniken / Tecniche di stampa.



(DG)
DIGITAL



MADE IN
SPAIN



68 MM X 75 MM ADHESIVE NOTEPADS **ecolutions®**

MADE OF 100% RECYCLED FIBRE*
& 100% RECYCLABLE



Sticky Notes ideal to always take your messages with you!

Decoration:

BIC® 68 MM X 75 MM ADHESIVE NOTEPADS
A DG: 4-colour process

MOQ 500u.

- 25 **ecolutions® 3500**
- 50 **ecolutions® 3530**
- 100 **ecolutions® 3560**

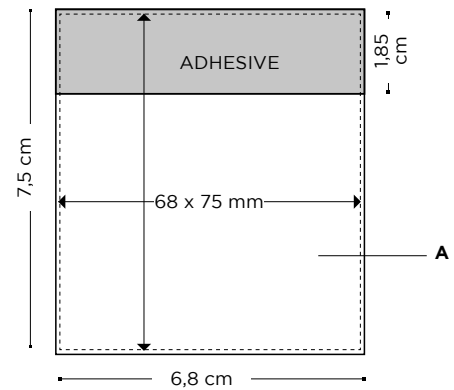

External Packaging:



500 ± 5,7 Kg

25



250 ± 5,4 Kg

50



130 ± 5,6 Kg

100

Exact colour match:

Correspondance exacte des couleurs / Color exacto / Exakte Farbübereinstimmung / Esatta corrispondenza di colore.

≥ 500 units

Paper type:

Type de papier / Tipo de papel / Papierart / Tipo carta.

Recycled 80g

Special packaging:

Emballage spécial / Envasado especial / Preis auf Anfrage / Confezione speciale.

shrink-wrapped

N° Sheets	Units per pack
25	10
50	5
100	1

Optional Packaging:
Cello Wrap 1, 2, 3 units

Printing techniques:

Techniques d'impression / Técnicas de impresión / Drucktechniken / Tecniche di stampa.



(DG)
DIGITAL



MADE IN
SPAIN

*The percentage is calculated excluding backsheet.
 *Pourcentage calculé hors dernière page.
 *Porcentaje calculado excluyendo la última página.
 *Der Prozentsatz ist ohne Rückblatt kalkuliert
 *La percentuale é calcolata escludendo il cartoncino di fondo.



75 MM X 75 MM ADHESIVE NOTEPADS **ecolutions®**

MADE OF 100% RECYCLED FIBRE*
& 100% RECYCLABLE



Large imprint area
in a small size!

Decoration:

**BIC® 75 MM X 75 MM
ADHESIVE NOTEPADS**
A DG: 4-colour process

MOQ 500u.

- 25 **ecolutions® 3505**
- 50 **ecolutions® 3535**
- 100 **ecolutions® 3565**

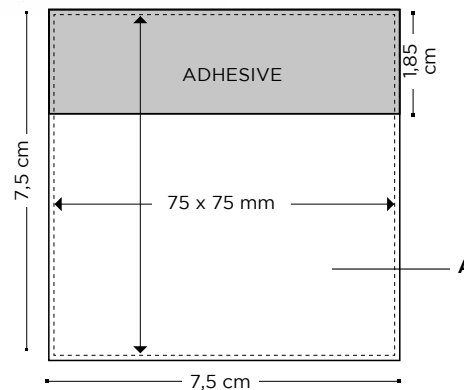

External Packaging:

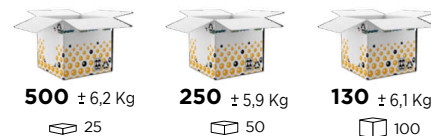

Exact colour match:

Correspondance exacte des couleurs / Color exacto / Exakte Farbübereinstimmung / Esatta corrispondenza di colore.

≥ 500 units

Paper type:

Type de papier / Tipo de papel / Papierart / Tipo carta.

Recycled 80g

Special packaging:

Emballage spécial / Envasado especial / Preis auf Anfrage / Confezione speciale.

shrink-wrapped

N° Sheets	Units per pack
25	10
50	5
100	1

Optional Packaging:

Cello Wrap 1, 2, 3 units

Printing techniques:

Techniques d'impression / Técnicas de impresión / Drucktechniken / Tecniche di stampa.



(DG)
DIGITAL



MADE IN SPAIN

MADE OF 100% RECYCLED FIBRE*
& 100% RECYCLABLE



Indispensable in any office!
Most popular sticky notes pad size!



Alternate 2 messages for
double-impact communication!

Decoration:

BIC® 101 MM X 75 MM ADHESIVE NOTEPADS	25 eco+olutions® 3510	MOQ 500u.
A DG: 4-colour process	50 eco+olutions® 3540	MOQ 250u.
	100 eco+olutions® 3570	MOQ 500u.

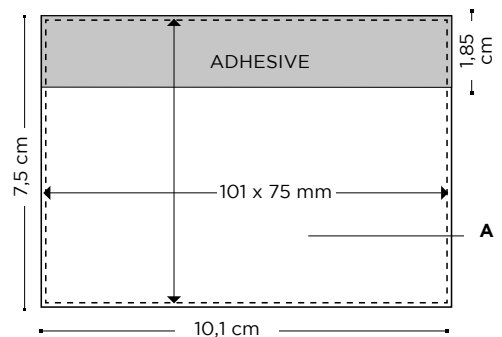

External Packaging:



Exact colour match:

Correspondance exacte des couleurs / Color exacto / Exakte Farbübereinstimmung / Esatta corrispondenza di colore.

≥ 500 units

Paper type:

Type de papier / Tipo de papel / Papierart / Tipo carta.

Recycled 80g

Special packaging:

Emballage spécial / Envasado especial / Preis auf Anfrage / Confezione speciale.

shrink-wrapped

N° Sheets	Units per pack
25	10
50	5
100	1

Optional Packaging:
Cello Wrap 1, 2, 3 units

Printing techniques:

Techniques d'impression / Técnicas de impresión / Drucktechniken / Tecniche di stampa.



(DG)
DIGITAL



MADE IN
SPAIN

*The percentage is calculated excluding backsheet.
*Pourcentage calculé hors dernière page.
*Porcentaje calculado excluyendo la última página.
*Der Prozentsatz ist ohne Rückblatt kalkuliert
*La percentuale é calcolata escludendo il cartoncino di fondo.



MADE WITH 100% FSC CERTIFIED PAPER
& 100% RECYCLABLE



Ecological products



125%

Choose from 28 stock shapes!
Custom-made shapes also available upon request

Exact colour match:

Correspondance exacte des couleurs / Color exacto / Exakte Farbübereinstimmung / Esatta corrispondenza di colore.

≥ 500 units

Paper type:

Type de papier / Tipo de papel / Papierart / Tipo carta.

Recycled 80g

Special packaging:

Emballage spécial / Envasado especial / Preis auf Anfrage / Confezione speciale.

shrink-wrapped

N° Sheets	Units per pack
25	10
50	5
100	1

Optional Packaging:
Cello Wrap 1, 2, 3 units

Printing techniques:

Techniques d'impression / Técnicas de impresión / Drucktechniken / Tecniche di stampa.



(DG)
DIGITAL









MADE IN SPAIN

Decoration:

Personnalisation / Personalización / Dekoration / Decorazione.

**BIC® MEDIUM ADHESIVE
DIE CUT NOTEPADS** **MOQ 500u.**

A DG: 4-colour process

-  25  3602
-  50  3606
-  100  3610

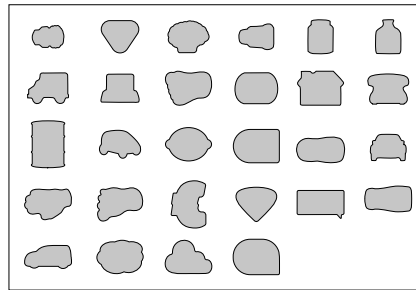
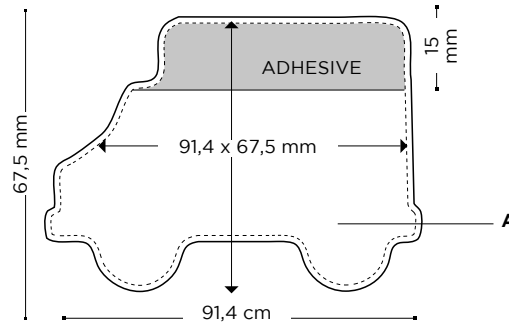

External packaging:

Emballage externe / Envasado exterior / Außenverpackung / Imballaggio esterno.

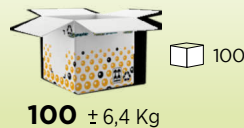
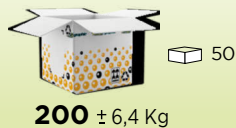
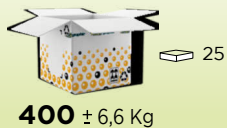

*The percentage is calculated excluding backsheet.
*Pourcentage calculé hors dernière page.
*Porcentaje calculado excluyendo la última página.
*Der Prozentsatz ist ohne Rückblatt kalkuliert
*La percentuale è calcolata escludendo il cartoncino di fondo.



MADE WITH 100% FSC CERTIFIED PAPER
& 100% RECYCLABLE



Ecological products

Exact colour match:

Correspondance exacte des couleurs / Color exacto / Exakte Farbübereinstimmung / Esatta corrispondenza di colore.

≥ 500 units

Paper type:

Type de papier / Tipo de papel / Papierart / Tipo carta.

Recycled 80g

Special packaging:

Emballage spécial / Envasado especial / Preis auf Anfrage / Confezione speciale.

shrink-wrapped

N° Sheets	Units per pack
25	10
50	5
100	1

Optional Packaging:
Cello Wrap 1, 2, 3 units

Printing techniques:

Techniques d'impression / Técnicas de impresión / Drucktechniken / Tecniche di stampa.



(DG)
DIGITAL



MADE IN
SPAIN

Decoration:

Personnalisation / Personalización / Dekoration / Decorazione.

BIC® 101 MM X 101 MM ADHESIVE NOTEPADS

MOQ 500u.

A DG: 4-colour process

-  25  3516
-  50  3546
-  100  3576

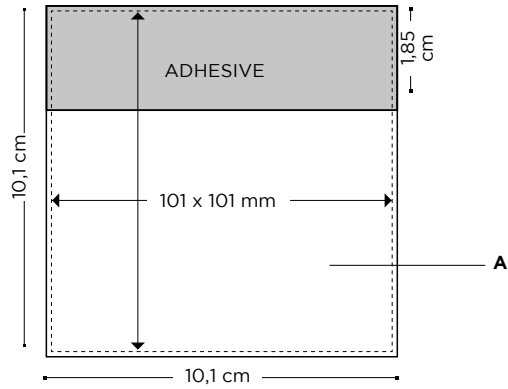

External packaging:

Emballage externe / Envasado exterior / Außenverpackung / Imballaggio esterno.

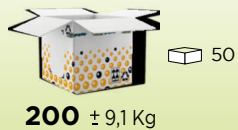
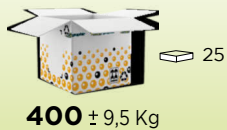

*The percentage is calculated excluding backsheets.

*Pourcentage calculé hors dernière page.

*Porcentaje calculado excluyendo la última página.

*Der Prozentsatz ist ohne Rückblatt kalkuliert

*La percentuale è calcolata escludendo il cartoncino di fondo.

MADE WITH 100% FSC CERTIFIED PAPER
& 100% RECYCLABLE

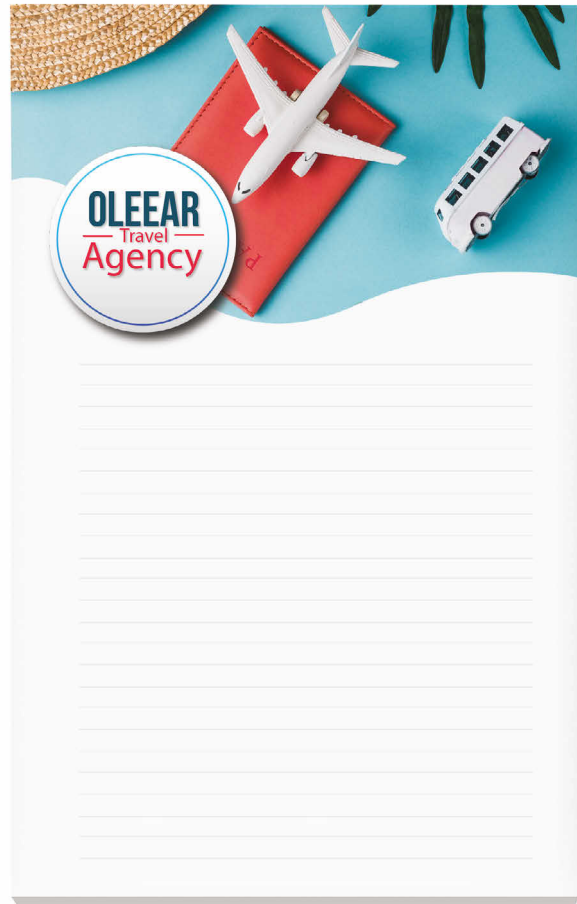
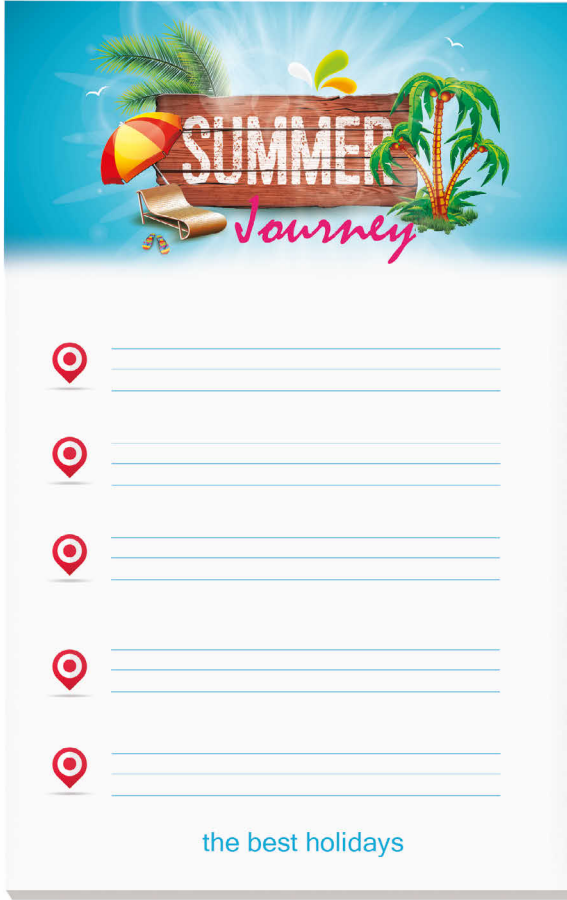

Large imprint area for big messages!
Don't miss anything!

Ecological products

130%

Exact colour match:

Correspondance exacte des couleurs / Color exacto / Exakte Farbübereinstimmung / Esatta corrispondenza di colore

≥ 500 units

Paper type:

Type de papier / Tipo de papel / Papierart / Tipo carta

Recycled 80g

Special packaging:

Emballage spécial / Envasado especial / Preis auf Anfrage / Confezione speciale.

shrink-wrapped

N° Sheets	Units per pack
25	10
50	5
100	1

Optional Packaging:
Cello Wrap 1, 2, 3 units

Printing techniques:

Techniques d'impression / Técnicas de impresión / Drucktechniken / Tecniche di stampa.



(DG)
DIGITAL



MADE IN SPAIN



Decoration:

Personnalisation / Personalización / Dekoration / Decorazione.

**BIC® 101 MM X 130 MM
ADHESIVE NOTEPADS**

MOQ 500u.

A DG: 4-colour process

-  25 3517 @colutions® 3515
-  50 3547 @colutions® 3545
-  100 3577 @colutions® 3575

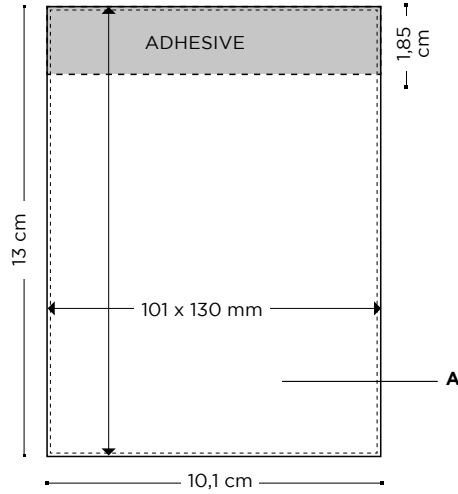

External packaging:

Emballage externe / Envasado exterior / Außenverpackung / Imballaggio esterno.

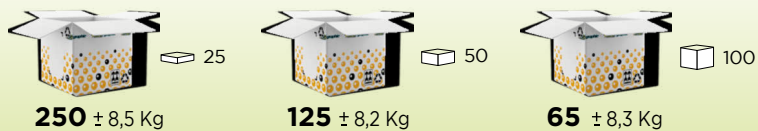

*The percentage is calculated excluding backsheet.
*Pourcentage calculé hors dernière page.
*Porcentaje calculado excluyendo la última página.
*Der Prozentsatz ist ohne Rückblatt kalkuliert
*La percentuale è calcolata escludendo il cartoncino di fondo.

FR> Nouvel emballage durable

Compagnon essentiel de nos produits

VALEUR ECOLOGIQUE

- Réduit et optimise le recyclage et les matériaux recyclés
- Réduit l'émission de carbone

EXPÉRIENCE BIC®

- Composant esthétique donnant une valeur ajoutée à l'instrument d'écriture
- Logo BIC® pour identifier la qualité et la valeur de la marque BIC.

DESIGN INTELLIGENT

- Évitez les produits jetables et réutilisez-les pour l'emballage
- Emballage disponible pour différents instruments d'écriture
- Emballage interactif avec un code QR

VALEUR SOCIALE

- Collaboration avec Treedom® pour la forêt Bic Graphic au Kenya
- Soutien des projets agro-locaux pour les populations locales au Kenya

MATÉRIAUX CERTIFIÉS

- Carton 100% recyclé
- Plastiques tels que PET, PP ou PS sont 100% recyclables
- Matières premières provenant de forêts durables (FSC)

Rejoignez notre forêt BIC Graphic Europe

L'emballage portant le logo Treedom® contribue à la création d'une forêt BIC Graphic au Kenya. Nous vous remercions de votre soutien, grâce à cette campagne, nous améliorons l'environnement (en réduisant les émissions de carbone) et nous pouvons soutenir les projets agroforestiers qui aident au développement des écosystèmes durables, à l'environnement et aussi aux personnes. Chaque arbre racontera sa propre histoire à travers des photos, des actualisations et les coordonnées GPS simples et faciles à utiliser. La forêt grandira avec le temps et vous pourrez le voir en direct.

Pour plus d'info :
www.treedom.net
Plantez votre arbre et regardez le pousser et aider l'environnement en direct.
Nouvel em
-90,100 kg co₂
Avec ce projet d'une nouvelle forêt BIC Graphic Europe

ES> nuevo packaging sostenible

Parte esencial de nuestro producto promocional.

VALOR ECOLÓGICO

- Reduce y optimiza material reciclado y reciclable.
- Reduce la huella del carbón.

EXPERIENCIA BIC®

- Componente estético dado y añadido valor a los instrumentos de escritura.
- Pequeños logos de BIC identifican la calidad y el valor de la marca BIC.

DISEÑO INTELIGENTE

- Evitar tirar productos con una segunda vida para el packaging.
- Packaging disponible para diferentes instrumentos de escritura.
- Packaging interactivo con código QR.

VALOR SOCIAL

- Cooperación con Treedom® con el bosque de BIC Graphic en Kenya.
- Apoyo en proyectos agro-locales para los habitantes de Kenya.

MATERIALES CERTIFICADOS

- 100% cartón reciclado.
- Plásticos como PET, PP o PS que son 100% reciclables.
- Materia prima de FSC.

Únete a nuestro BIC Graphic Europe Forest

El packaging con el logo de Treedom® coopera con la creación de de BIC Graphic Forest en Kenya. Gracias a tu apoyo en esta campaña podemos mejorar el medio ambiente (reduciendo la huella de carbón) i apoyando proyectos agro-forestales que implementan los ecosistemas sostenibles, ayudando así al medio ambiente y a las personas. Todos los árboles narrarán su historia, con fotos, actualizaciones y coordinadas GPS con total transparencia. El bosque crecerá con el tiempo y se podrá seguir online.

Más información en
www.treedom.net
Planta tu árbol y síguelo online para ver cómo ayuda al medioambiente.
-90,100 kg co₂
con el establecimiento de la nuevo bosque BIC® Graphic Europe.

DE> Neues, nachhaltiges Verpackungsmaterial.

Ein wesentlicher Teil unseres Werbeproduktes

ÖKOLOGISCHER WERT

- Reduziere und optimiere recyceltes und recycelbares Material

- Reduziere die CO2 Bilanz

BIC ERFABUNG

- Ästhetische Komponente steigert den Wert von Schreibinstrumenten
- Kleines BIC Logo identifiziert die Qualität und den Wert der BIC Marke

CLEVERES DESIGN

- Vermeide Wegwerfprodukte mit einem zweiten Leben für die Verpackung
- Verpackungen erhältlich für verschiedene Schreibinstrumente
- Interaktive Verpackung mit QR-Code

SOZIALER WERT

- Zusammenarbeit mit Treedom® mit dem BIC Graphic Wald in Kenia
- Lokale Agrar-Projekte zur Unterstützung der Menschen in Kenia

ZERTIFIZIERTE MATERIALIEN

- 100 % recycelte Pappe
- PET, PP oder PS Plastik ist zu 100 % recycelbar
- Rohmaterialien aus nachhaltigen Wäldern (FSC)

Lass uns an unserem BIC Graphic Europe Wald teilnehmen

Die Verpackung mit dem Treedom® Logo arbeitet mit der Entstehung des BIC Graphic Forrest in Kenia zusammen. Dank Ihrer Unterstützung dieser Kampagne können wir die Umwelt verbessern (CO2 Bilanz reduzieren) und Agrar-Waldprojekte unterstützen, die nachhaltige Ökosysteme implementieren. Dies hilft der Umwelt und auch Menschen. Alle Bäume werden ihre Geschichte erzählen, mit Fotos, Updates und GPS Koordinaten, mit absoluter Transparenz. Der Wald wird mit der Zeit wachsen und das kann online verfolgt werden.

Mehr Informationen unter
www.treedom.net
Pflanzen Sie ihren Baum und folgen Sie ihm online, weil es der Umwelt hilft
-90,100 kg co₂
Mit der Gründung des neuen BIC Graphic Europe Forest

IT> Nuova confezione sostenibile

Parte essenziale dei nostri prodotti promozionali

VALORE ECOLOGICO

- Riduce e ottimizza i materiali riciclati e riciclabili.
- Riduce l'impatto ambientale.

ESPERIENZA BIC®

- Fattore estetico che conferisce valore aggiunto agli strumenti di scrittura
- Il piccolo logo BIC identifica la qualità e il valore del brand BIC.

DESIGN SMART

- Si evitano i prodotti usa e getta dando una seconda vita agli imballaggi
- Imballaggi disponibili per diversi strumenti di scrittura.
- Imballaggi interattivi dotati di codici QR.

VALORE SOCIALE

- Cooperazione con Treedom® nell'ambito della foresta BIC Graphic in Kenya.
- Supporto di progetti agricoli per la popolazione locale in Kenya.

MATERIALI CERTIFICATI

- 100% di cartone riciclato.
- Plastiche come PET, PP o PS 100% riciclabili.
- Materie prime provenienti da foreste sostenibili (FSC).

Contribuisci a creare la foresta di BIC Graphic Europe

Gli imballaggi con il logo Treedom® contribuiscono alla creazione della BIC Graphic Forest in Kenya. Grazie al vostro contributo, attraverso questa campagna, potremo migliorare l'ambiente (riducendo l'impatto ambientale) e sostenere progetti agro-forestali che contribuiscono a migliorare gli ecosistemi rendendoli sostenibili. Aiutando l'ambiente e, quindi, anche le persone. Tutti gli alberi potranno raccontare la loro storia, attraverso foto, aggiornamenti e coordinate GPS in totale trasparenza. La foresta crescerà nel tempo e potrà essere seguita online.

Per ulteriori informazioni
www.treedom.net
Pianta il tuo albero e seguilo online: contribuirà a migliorare l'ambiente
-90,100 kg co₂
grazie alla creazione della BIC® Graphic Europe Forest



New sustainable packaging

Essential part of our products



ECOLOGICAL VALUE

- Reduce and optimize recycled and recyclable materials.
- Reduce the carbon footprint.

BIC® EXPERIENCE

- Aesthetic component giving an added value to writing instruments.
- BIC® logo to identify the quality and value of BIC® brand.



SMART DESIGN

- Avoid throw-away products with a second life for the packaging.
- Packaging available for different writing instruments.
- Interactive packaging with QR code.

SOCIAL VALUE

- Cooperation with Treedom® with the BIC Graphic forest in Kenya.
- Support agro-local projects for local people in Kenya.

CERTIFIED MATERIALS

- 100% Recycled cardboard.
- Plastics such as PET, PP or PS that are 100% recyclable.
- Raw materials from sustainable forest (FSC).

Let's join to our BIC Graphic Europe forest

The packaging with the Treedom® logo is contributing to the creation of the BIC Graphic Forest in Kenya. Thanks to your support, with this campaign, we can improve the environment (reducing the carbon footprint) and support agro-forestry projects that implement sustainable ecosystems. Helping the environment and also people. All trees will narrate their history, with photos, updates and GPS coordinates with total transparency. The forest will grow over time and can be followed online.

More info in www.treedom.net



Plant your tree and follow it online as it helps the environment



-90,100 KG CO₂

with the establishment of the new BIC Graphic Europe Forest



Learn more here

BIC ECO SLEEVE *New!*

985240
 Special recycled sleeve for all BIC® writing instruments except graphite pencils.
 Pochette spéciale recyclée pour tous les instruments d'écriture BIC® à l'exception des crayons papier.
 Funda especial reciclada para todos los instrumentos de escritura BIC excepto los lápices de grafito.
 Spezieller recycelter Schaft für alle BIC® Schreibgeräte ausgenommen Bleistifte.
 Astuccio riciclato opzionale per tutti gli strumenti di scrittura BIC eccetto le matite.



Special packaging for pens with clip printed:

- BIC** MEDIA CLIC
- BIC** WIDE BODY
- BIC** CLIC STIC
- BIC** ATLANTIS
- BIC** SUPER CLIP
- BIC** FINE STYLE

Check out Treedom initiative:



BIC WINDOW BOX *New!*

985241
 Premium design packaging for all BIC® writing instruments except graphite pencils.

Emballage design haut de gamme pour tous les instruments d'écriture BIC® à l'exception des crayons papier.
 Envasado de diseño premium para todos los instrumentos de escritura BIC® excepto los lápices de grafito.
 Premium-Designverpackung für alle BIC® Schreibgeräte ausgenommen Bleistifte.
 Astuccio dal design premium adatto a tutti gli strumenti di scrittura BIC® eccetto le matite.



Special packaging for:

- BIC** METAL PENS

Check out Treedom initiative:

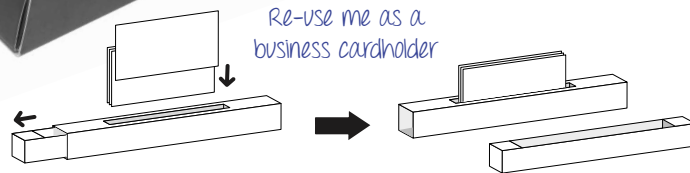

BIC PLASTIC POUCH *New!*

985242
 Special design for this packaging which fits in any writing instruments and for 3 graphite pencils.

Design spécial pour cet emballage qui s'adapte à tous les instruments d'écriture et pour 3 crayons papier.
 Diseño especial para este envasado que encaja con todos los instrumentos de escritura BIC y los 3 lápices de grafito.
 Ein speziell für diese Verpackung entworfenes Design, das Platz für jedes Schreibgerät sowie drei Bleistifte bietet.
 Design special per questa confezione adatta per ogni strumento di scrittura e per 3 matite.



Use me as bookmark

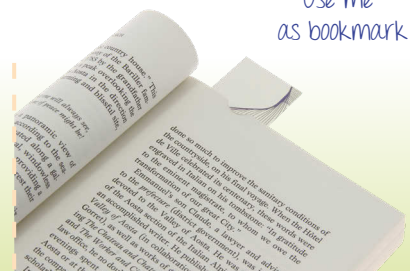

BIC MARKING SET *New!*

985243

Packaging designed for all types of markers products.

Emballage conçu pour tous les types de stylos marqueurs.

Envasado diseñado para todo tipo de marcadores.

Die Verpackung wurde für alle Arten von Markern entworfen.

Confezione adatta a ogni marker.



Special packaging for pens with clip printed:

- BIC** 3 BRITELINER **BIC** 3 *Velleda* GRIP
- BIC** 3 MARK-IT **BIC** 4 *Velleda* FINE

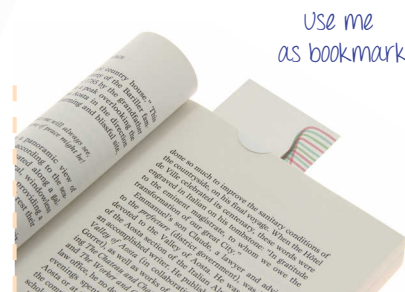

BIC GIFT BOX *New!*

985241

Special set of notebooks and writing instruments.

Set spécial pour cahiers et instruments d'écriture.

Envasado diseñado para todo tipo de marcadores.

Ein Spezialset bestehend aus Notizblöcken und

Schreibgeräten.

Confezione opzionale per set notebook e strumenti di scrittura.



Special packaging for Dual Notebook A5 & A6 and:

- BIC** 4-COLOURS (SP)
- BIC** MEDIA CLIC (SP)
- BIC** SUPER CLIP (SP)

BIC OUTER BOXES

Special design for all the outer boxes related with all the writing instruments.

Design spéciale pour toutes les boîtes extérieures liées à tous les instruments d'écriture.

Diseño especial para todas las cajas exteriores de todos los instrumentos de escritura.

Spezielles Design für alle Außenverpackungen von Schreibgeräten.

Cartone esterno con design speciale per tutti gli strumenti di scrittura.





www.bicgraphic.eu